

# Operation

Engine

Models:

**KG2204 Naturally Aspirated  
KG2204T Turbocharged  
Propane, Liquefied Petroleum Gas (LPG)  
Natural Gas (NG) Fueled**

**KOHLER®**

TP-6901 9/19c

**▲ WARNING:** This product can expose you to chemicals, including carbon monoxide and benzene, which are known to the State of California to cause cancer and birth defects or other reproductive harm. For more information go to [www.P65warnings.ca.gov](http://www.P65warnings.ca.gov)

## Product Identification Information

---

Product identification numbers determine service parts. Record the product identification numbers in the spaces below immediately after unpacking the products so that the numbers are readily available for future reference.

### Engine Identification

Record the product identification information from the engine nameplate.

Model Designation: \_\_\_\_\_

Serial Number: \_\_\_\_\_

### Purchase Date

Upon purchase of your Kohler equipment, record the purchase date for reference when communicating with your authorized Kohler distributor/dealer.

# Table of Contents

<b>Safety Precautions and Instructions</b> .....	<b>5</b>
<b>Introduction</b> .....	<b>13</b>
<b>Service Assistance</b> .....	<b>14</b>
<b>Section 1. Components and Maintenance Locations</b> .....	<b>15</b>
1.1 Model KG2204 Engine Side Views.....	15
1.2 Model KG2204 Front and Rear Views.....	16
1.3 Model KG2204T Engine Side Views .....	17
1.4 Model KG2204T Front and Rear Views.....	18
<b>Section 2. Operation</b> .....	<b>19</b>
2.1 Introduction .....	19
2.2 Fuel System .....	19
2.2.1 Components.....	19
2.2.2 Fuel Specifications.....	25
2.2.3 NG to LPG Conversion .....	26
2.3 Before Starting .....	28
2.4 Starting.....	29
2.5 Cold Weather Starting .....	30
2.6 Monitoring Engine Operation.....	31
2.7 Stopping.....	31
<b>Section 3. Maintenance</b> .....	<b>33</b>
3.1 Introduction .....	33
3.2 Safety Precautions and Instructions .....	33
3.3 Fluid Specifications .....	35
3.3.1 Oil Recommendations.....	35
3.3.2 Grease Recommendations .....	35
3.3.3 Coolant Recommendations.....	35
3.4 Periodic Maintenance Schedule .....	36
3.5 Engine .....	37
3.5.1 Check Engine Oil .....	37
3.5.2 Change Engine Oil and Oil Filter.....	39
3.5.3 Check and Clean the Air Filter .....	42
3.5.4 Replace the Air Filter .....	42
3.5.5 Check, Adjust and Replace the Spark Plugs.....	42
3.5.6 Ignition Timing.....	44
3.6 Electrical System.....	45
3.6.1 Check Battery and Connections.....	45
3.6.2 Check and Adjust the Drive Belt .....	46
3.6.3 Replace the Drive Belt .....	48
3.6.4 Check Wiring and Electrical Connections .....	50
3.7 Cooling system.....	51
3.7.1 Check Coolant Level and Condition .....	51
3.7.2 Check Hoses and Clamps.....	51
3.7.3 Draining and Replacing the Coolant .....	51
3.8 Fuel System .....	52
3.8.1 Check Fuel Supply Pipe and Connections .....	52
3.8.2 Check Fuel Level (LPG only) .....	52
<b>Section 4. Troubleshooting</b> .....	<b>53</b>
4.1 Introduction .....	53
4.2 Troubleshooting .....	53
<b>Section 5. Storage</b> .....	<b>55</b>

5.1	Preparation.....	55
5.2	Short-Term Storage (Less than 30 Days).....	55
5.3	Long-Term Storage (More than 30 Days).....	56
5.4	Maintenance while in Storage .....	56
5.5	Removal from Storage .....	56
<b>Section 6.</b>	<b>Specifications.....</b>	<b>57</b>
6.1	Engine Specifications .....	57
6.2	Main Components Specifications .....	57
6.3	Adjustment Specifications .....	58
6.4	Torque Specifications.....	58
6.5	Standard Torque Specifications .....	59

# Safety Precautions and Instructions

Read and follow all safety precautions and instructions. SAVE THESE INSTRUCTIONS.

This manual has several types of safety precautions and instructions: Danger, Warning, Caution, and Notice.



Danger indicates the presence of a hazard that **will cause severe personal injury, death, or substantial property damage.**



Warning indicates the presence of a hazard that **can cause severe personal injury, death, or substantial property damage.**



Caution indicates the presence of a hazard that **will or can cause minor personal injury or property damage.**

## NOTICE

Notice communicates installation, operation, or maintenance information that is safety related but not hazard related.

### Note:



A Note is used to inform you of important installation, operation, or maintenance information.

## Accidental Starting

	<p><b>Accidental starting.</b> <b>Can cause severe injury or death.</b></p> <p>Disconnect the battery cables before working on the engine. Remove the negative (-) lead first when disconnecting the battery. Reconnect the negative (-) lead last when reconnecting the battery.</p>

**Disabling the engine. Accidental starting can cause severe injury or death.** Before working on the engine or connected equipment, disable the engine as follows: 1) Disconnect the ignition coil. 2) Remove the battery cables, negative (-) lead first. Reconnect the negative (-) lead last when reconnecting the battery. Follow these precautions to prevent the accidental starting of the engine.

## Battery

 <b>WARNING</b>	<b>Sulfuric acid in batteries.</b> <b>Can cause severe injury or death.</b>
	Wear protective goggles and clothing. Battery acid may cause blindness and burn skin.



**Battery electrolyte is a diluted sulfuric acid. Battery acid can cause severe injury or death.** Battery acid can cause blindness and burn skin. Always wear splashproof safety goggles, rubber gloves, and boots when servicing the battery. Do not open a sealed battery or mutilate the battery case. If battery acid splashes in the eyes or on the skin, immediately flush the affected area for 15 minutes with large quantities of clean water. Seek immediate medical aid in the case of eye contact. Never add acid to a battery after placing the battery in service, as this may result in hazardous spattering of battery acid.

**Battery acid cleanup. Battery acid can cause severe injury or death.** Battery acid is electrically conductive and corrosive. Add 500 g (1 lb.) of bicarbonate of soda (baking soda) to a container with 4 L (1 gal.) of water and mix the neutralizing solution. Pour the neutralizing solution on the spilled battery acid and continue to add the neutralizing solution to the spilled battery acid until all evidence of a chemical reaction (foaming) has ceased. Flush the resulting liquid with water and dry the area.

**Battery gases. Explosion can cause severe injury or death.** Battery gases can cause an explosion. Do not smoke or permit flames or sparks to occur near a battery at any time, particularly when it is charging. Do not dispose of a battery in a fire. To prevent burns and sparks that could cause an explosion, avoid touching the battery terminals with tools or other metal objects. Remove all jewelry before servicing the equipment. Discharge static electricity from your body before touching batteries by first touching a grounded metal surface away from the battery. To avoid sparks, do not disturb the battery charger connections while the battery is charging. Always turn the battery charger off before disconnecting the battery connections. Ventilate the compartments containing batteries to prevent accumulation of explosive gases.

**Battery short circuits. Explosion can cause severe injury or death.** Short circuits can cause bodily injury and/or equipment damage. Disconnect the battery before maintenance. Remove all jewelry before servicing the equipment. Use tools with insulated handles. Remove the negative (-) lead first when disconnecting the battery. Reconnect the negative (-) lead last when reconnecting the battery. Never connect the negative (-) battery cable to the positive (+) connection terminal of the starter solenoid. Do not test the battery condition by shorting the terminals together.

## Engine Backfire/Flash Fire

 <b>WARNING</b>	<b>Risk of fire.</b> <b>Can cause severe injury or death.</b>
	Do not smoke or permit flames or sparks near fuels or the fuel system.



**Servicing the fuel system. A flash fire can cause severe injury or death.** Do not smoke or permit flames or sparks near the fuel mixer, fuel line, fuel filter, or other potential sources of fuel vapors. When removing the fuel line or fuel system be aware that liquid propane can cause frostbite on contact.

**Servicing the air cleaner. A sudden backfire can cause severe injury or death.** Do not operate the engine with the air cleaner/silencer removed.

**Combustible materials. A fire can cause severe injury or death.** Engine fuels and fuel vapors are flammable and explosive. Handle these materials carefully to minimize the risk of fire or explosion. Equip the compartment or nearby area with a fully charged fire extinguisher. Select a fire extinguisher rated ABC or BC for electrical fires or as recommended by the local fire code or an authorized agency. Train all personnel on fire extinguisher operation and fire prevention procedures.

**Troubleshooting and/or repairing the sensors or the ECM. A backfire due to an open fuel shut-off valve can cause severe injury or death.** If power is supplied to the shut-off valve during ECM or sensor troubleshooting, fuel may enter the air intake manifold or the air cleaner and cause a backfire. Make sure that the fuel supply is turned OFF and that the fuel supply valves are DISCONNECTED from the power source BEFORE turning the ECM power on.



## Engine Fluids and Chemical Products

 <b>WARNING</b>	<b>Handling caustic engine fluids and chemical products.</b> <b>Can cause severe chemical burns, nausea, fainting, or death.</b>
	Most chemicals such as used engine oil, antifreeze/coolant, rustproofing agent, inhibiting oil, degreasing agent, spray paint, and adhesives are hazardous to health. Read and follow the user information found on the packaging. Avoid inhalation and skin contact. Use only in well-ventilated areas and use a protective mask when spraying. Store engine fluids and chemical products in a locked cabinet. Contact your local recycling center for disposal information and locations.

**Fire-damaged or burned O-rings may cause the formation of hydrofluoric acid. Contact with hydrofluoric acid may cause severe skin irritation and chemical burns.** O-rings and other fluoroelastomer seals exposed to fire or temperatures above 316°C (600°F) (i.e., during welding) may decompose forming hydrofluoric acid. Avoid inhalation or skin contact. Do not incinerate O-rings. Dispose of O-ring waste material in a responsible manner.

**Used engine oil. Contact with used engine oil may cause severe skin irritation. Repeated and prolonged skin exposure may have other health risks.** Used engine oil is a suspected carcinogen. Avoid contact with skin. Thoroughly wash your hands and nails with soap and water shortly after handling used engine oil. Wash or dispose of clothing or rags containing used engine oil. Dispose of used engine oil in a responsible manner. Contact your local recycling center for disposal information and locations.



## Exhaust System

 <b>WARNING</b>	<p><b>Carbon monoxide.</b>  <b>Can cause severe nausea, fainting, or death.</b>            The exhaust system must be leakproof and routinely inspected.</p>
	

**Carbon monoxide symptoms. Carbon monoxide can cause severe nausea, fainting, or death.** Carbon monoxide is a poisonous gas present in exhaust gases. Carbon monoxide is an odorless, colorless, tasteless, nonirritating gas that can cause death if inhaled for even a short time. Carbon monoxide poisoning symptoms include but are not limited to the following:

- Light-headedness, dizziness
- Physical fatigue, weakness in joints and muscles
- Sleepiness, mental fatigue, inability to concentrate or speak clearly, blurred vision
- Stomachache, vomiting, nausea



If experiencing any of these symptoms and carbon monoxide poisoning is possible, seek fresh air immediately and remain active. Do not sit, lie down, or fall asleep. Alert others to the possibility of carbon monoxide poisoning. Seek medical attention if the condition of affected persons does not improve within minutes of breathing fresh air.

 <b>WARNING</b>	<p><b>Carbon monoxide.</b>  <b>Can cause severe nausea, fainting, or death.</b>            Avoid inhaling exhaust fumes.</p>
	

**Engine Operation. Carbon monoxide can cause severe nausea, fainting, or death.** Engine exhaust gases contain poisonous carbon monoxide. Carbon monoxide is an odorless, colorless, tasteless, nonirritating gas that can cause death if inhaled for even a short time. Avoid breathing exhaust fumes when working on or near the engine. Never operate the engine inside a building. Never operate the engine where exhaust gas could seep inside or be drawn into a potentially occupied building through windows, air intake vents, or other openings.



## Fuel System



 <b>WARNING</b>	<b>Explosive fuel vapors. Can cause severe injury or death.</b>
	Use extreme care when handling, storing, and using fuels.

**The fuel system. Explosive fuel vapors can cause severe injury or death.** Vaporized fuels are highly explosive. Use extreme care when handling and storing fuels. Store fuels in a well-ventilated area away from spark-producing equipment and out of the reach of children. Never add fuel to the tank while the engine is running because spilled fuel may ignite on contact with hot parts or from sparks. Do not smoke or permit flames or sparks to occur near sources of spilled fuel or fuel vapors. Keep the fuel lines and connections tight and in good condition. Do not replace flexible fuel lines with rigid lines. Use flexible sections to avoid fuel line breakage caused by vibration. Do not operate the engine in the presence of fuel leaks, fuel accumulation, or sparks. Repair fuel systems before resuming engine operation.

**Explosive fuel vapors can cause severe injury or death.** Take additional precautions when using the following fuels:



**Propane (LPG)**—Adequate ventilation is mandatory. Because propane is heavier than air, install propane gas detectors low in a room. Inspect the detectors per the manufacturer's instructions.

**Natural Gas**—Adequate ventilation is mandatory. Because natural gas rises, install natural gas detectors high in a room. Inspect the detectors per the manufacturer's instructions.













 <b>WARNING</b>	<b>Explosive fuel vapors. Can cause fires and severe burns.</b>
	If a gaseous odor is detected, ventilate the area and contact an authorized service technician.

**Gas fuel leaks. Explosive fuel vapors can cause severe injury or death.** Fuel leakage can cause an explosion. Check the LPG vapor or natural gas fuel system for leakage by using a soap and water solution with the fuel system test pressurized to 6–8 ounces per square inch (10–14 inches water column). Do not use a soap solution containing either ammonia or chlorine because both prevent bubble formation. A successful test depends on the ability of the solution to bubble.

## Hazardous Noise



 <b>CAUTION</b>	<b>Hazardous noise. Can cause hearing loss.</b>
	Never operate the engine without a muffler or with a faulty exhaust system.

## Hazardous Voltage/Moving Parts



 <b>CAUTION</b>	<b>Hazardous voltage.</b> <b>Electrical shock can cause injury.</b>
	Do not touch wires while the engine is running. Stop the engine and disconnect the battery leads, negative (-) lead first, before servicing the engine.
 <b>WARNING</b>	<b>Spring-loaded parts.</b> <b>Can cause severe personal injury or property damage.</b>
	Wear protective goggles when servicing spring-loaded parts. Hold parts securely during disassembly.
 <b>WARNING</b>	<b>Airborne particles.</b> <b>Can cause severe injury or blindness.</b>
	Wear protective goggles and clothing when using power tools, hand tools, or compressed air.
 <b>CAUTION</b>	<b>Damaged harmonic balancer, crankshaft, or flywheel.</b> <b>Can cause personal injury.</b>
	Broken fragments from the harmonic balancer, crankshaft, and flywheel can be thrown from the engine. Do not use a hammer to install or remove. Inspect these parts for damage and replace if needed.
 <b>WARNING</b>	<b>Pinch and entanglement hazards.</b> <b>Can cause severe injury and possible death.</b>
	Never check drive belt tension while the engine is running.
 <b>WARNING</b>	<b>Moving parts.</b> <b>Can cause severe injury or death.</b>
	Operate the engine only when all guards and electrical enclosures are in place. Stay away from moving parts while the engine is in operation.

**Servicing the engine when it is operating. Exposed moving parts can cause severe injury or death.** Keep hands, feet, hair, clothing, and test leads away from the belts and pulleys when the engine is running. Replace guards, screens, and covers before operating the engine.

## Heavy Equipment



 <b>WARNING</b>	<p><b>Unbalanced weight.</b> <b>Improper lifting can cause severe injury or death and equipment damage.</b></p> <p>Use adequate lifting capacity. Always maintain a safe distance from the equipment being lifted. Never stand under the equipment.</p>
	

## Hot Parts

 <b>WARNING</b>	<p><b>Hot engine and exhaust system.</b> <b>Can cause severe injury or death.</b></p> <p>Do not work on the engine until it cools.</p>
	

**Servicing the exhaust system. Hot parts can cause severe injury or death.** Do not touch hot engine parts. The engine and exhaust system components become extremely hot during operation.

**Hot engine components. Can cause severe injury or death.** Never operate the engine with heat shields or guards removed.

 <b>WARNING</b>	<p><b>Hot coolant and steam.</b> <b>Can cause severe injury or death.</b></p> <p>Before removing the pressure cap, stop the engine and allow it to cool. Then loosen the pressure cap to relieve pressure.</p>
	



This manual provides operating and maintenance instructions for Kohler engines. Keep this manual with the equipment for future reference. Refer to the service manual for detailed information on adjusting and servicing the engine.

Read this manual and carefully follow all procedures and safety precautions to ensure proper equipment operation and to avoid bodily injury. Read and follow the Safety Precautions and Instructions section at the beginning of this manual. Keep this manual with the equipment for future reference.

Information in this publication represents data available at the time of print. Kohler Co. reserves the right to change this publication and the products represented without notice and without any obligation or liability whatsoever.

This engine operates on either propane, liquefied petroleum gas (LPG), or natural gas (NG), which are extremely flammable and explosive. Installation and repair of LPG/NG systems must be performed only by qualified technicians. Read this manual and carefully follow all procedures and safety precautions to ensure proper equipment operation and to avoid bodily injury.

Regular maintenance is necessary for safe and efficient operation. Inspect the engine often and perform required maintenance at prescribed intervals. Service work must be performed by appropriately skilled and suitably trained maintenance personnel who are familiar with engine diagnostics and repair.

Unless otherwise specified, all units of measurement are metric, followed by the United States customary unit equivalent.

## Related Literature

The following chart identifies related literature available for the KG2204/KG2204T engines. Only trained and qualified personnel should install or service this engine.

Literature Type	Part Number
Engine Service Manual	TP-6902
Engine Service Manual, ECM Troubleshooting and Diagnostics	TP-6903
Engine Service Parts Manual	TP-6904

Contact a Kohler authorized distributor/dealer for all maintenance, service, and engine parts. To find a Kohler authorized distributor/dealer, visit [KOHLERPower.com](http://KOHLERPower.com) or call 1-800-544-2444 (U.S. and Canada).

## Service Assistance

---

For professional advice and conscientious service, please contact your nearest Kohler distributor or dealer.

- Visit the Kohler Co. website at KOHLERPower.com.
- Look at the labels and decals on your Kohler product or review the appropriate literature or documents included with the product.
- Call toll free in the US and Canada 1-800-544-2444.
- Outside the US and Canada, call the nearest regional office.

### Headquarters Europe, Middle East, Africa (EMEA)

Kohler EMEA Headquarters  
Netherlands B.V.  
Kristallaan 1  
4761 ZC Zevenbergen  
The Netherlands  
Phone: (31) 168 331630  
Fax: (31) 168 331631

### Asia Pacific

Kohler Asia Pacific Headquarters  
Singapore, Republic of Singapore  
Phone: (65) 6264-6422  
Fax: (65) 6264-6455

### China

North China Regional Office, Beijing  
Phone: (86) 10 6518 7950  
(86) 10 6518 7951  
(86) 10 6518 7952  
Fax: (86) 10 6518 7955

East China Regional Office, Shanghai  
Phone: (86) 21 6288 0500  
Fax: (86) 21 6288 0550

### India, Bangladesh, Sri Lanka

India Regional Office  
Bangalore, India  
Phone: (91) 80 3366208  
(91) 80 3366231  
Fax: (91) 80 3315972

### Japan, Korea

North Asia Regional Office  
Tokyo, Japan  
Phone: (813) 3440-4515  
Fax: (813) 3440-2727

# Section 1. Components and Maintenance Locations

## 1.1 Model KG2204 Engine Side Views

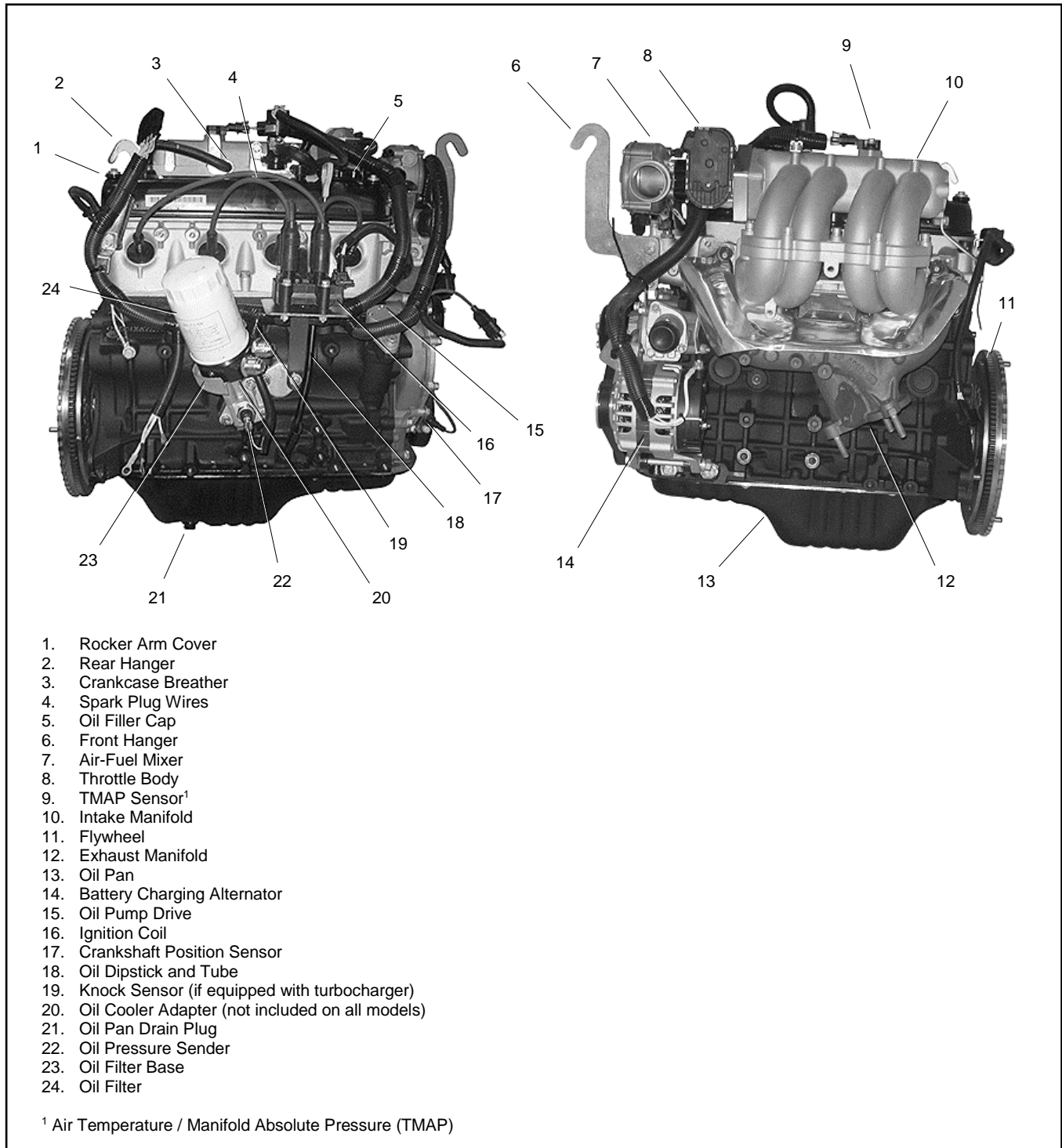

Figure 1 KG2204 Engine Side Views

## 1.2 Model KG2204 Front and Rear Views

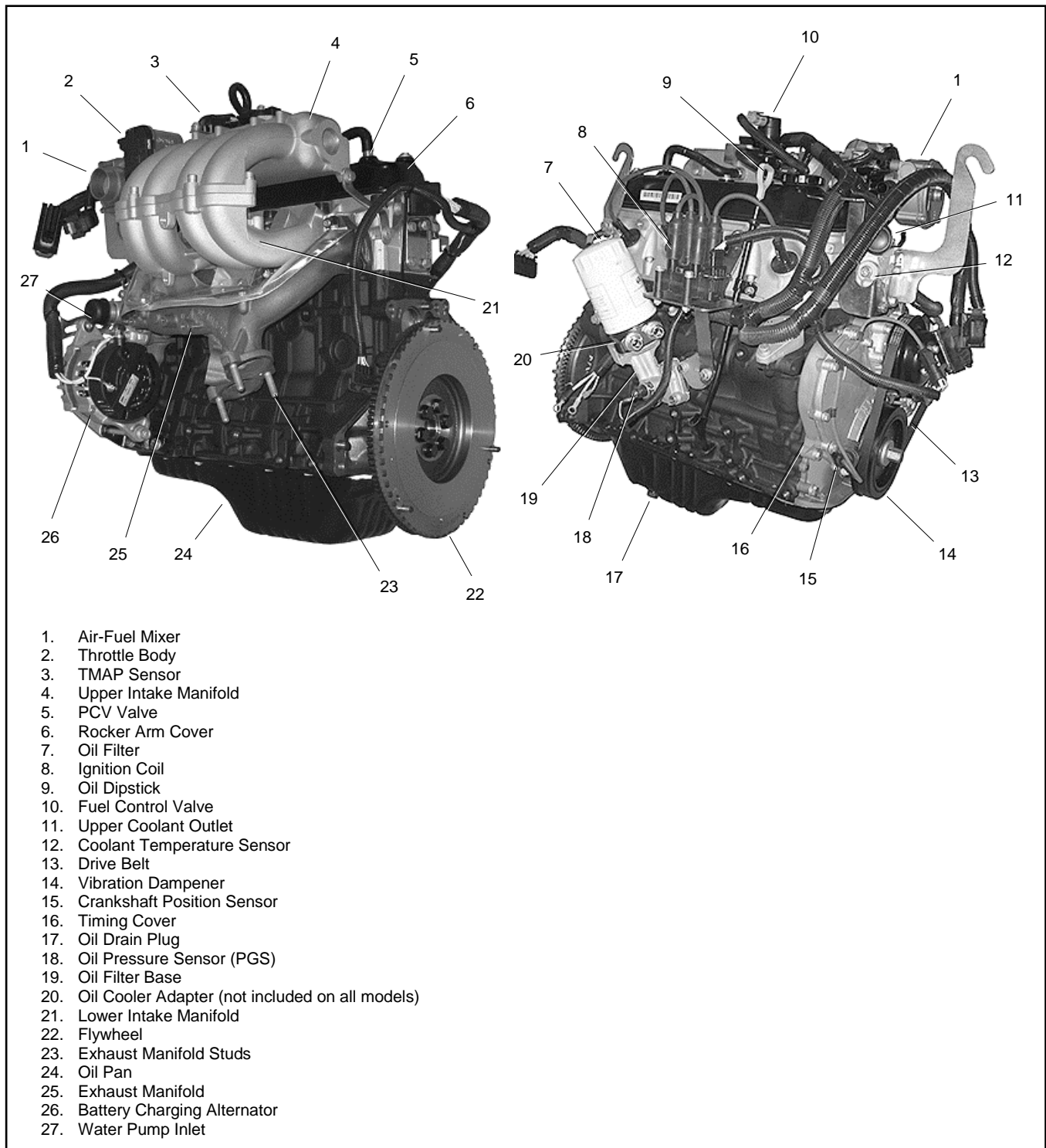

Figure 2 KG2204 Engine Front and Rear Views



### 1.3 Model KG2204T Engine Side Views

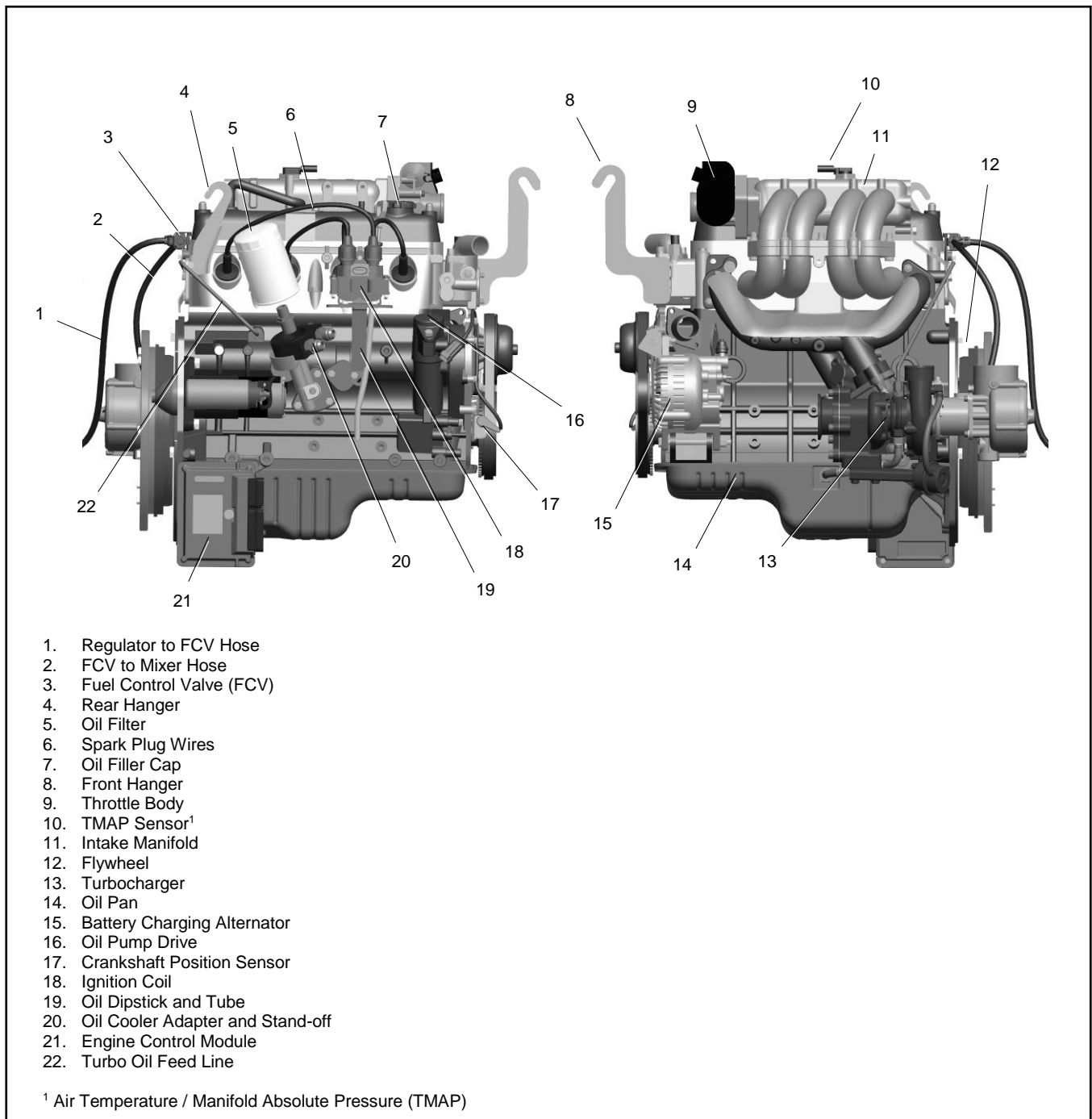

Figure 3 KG2204T Engine Side Views

## 1.4 Model KG2204T Front and Rear Views

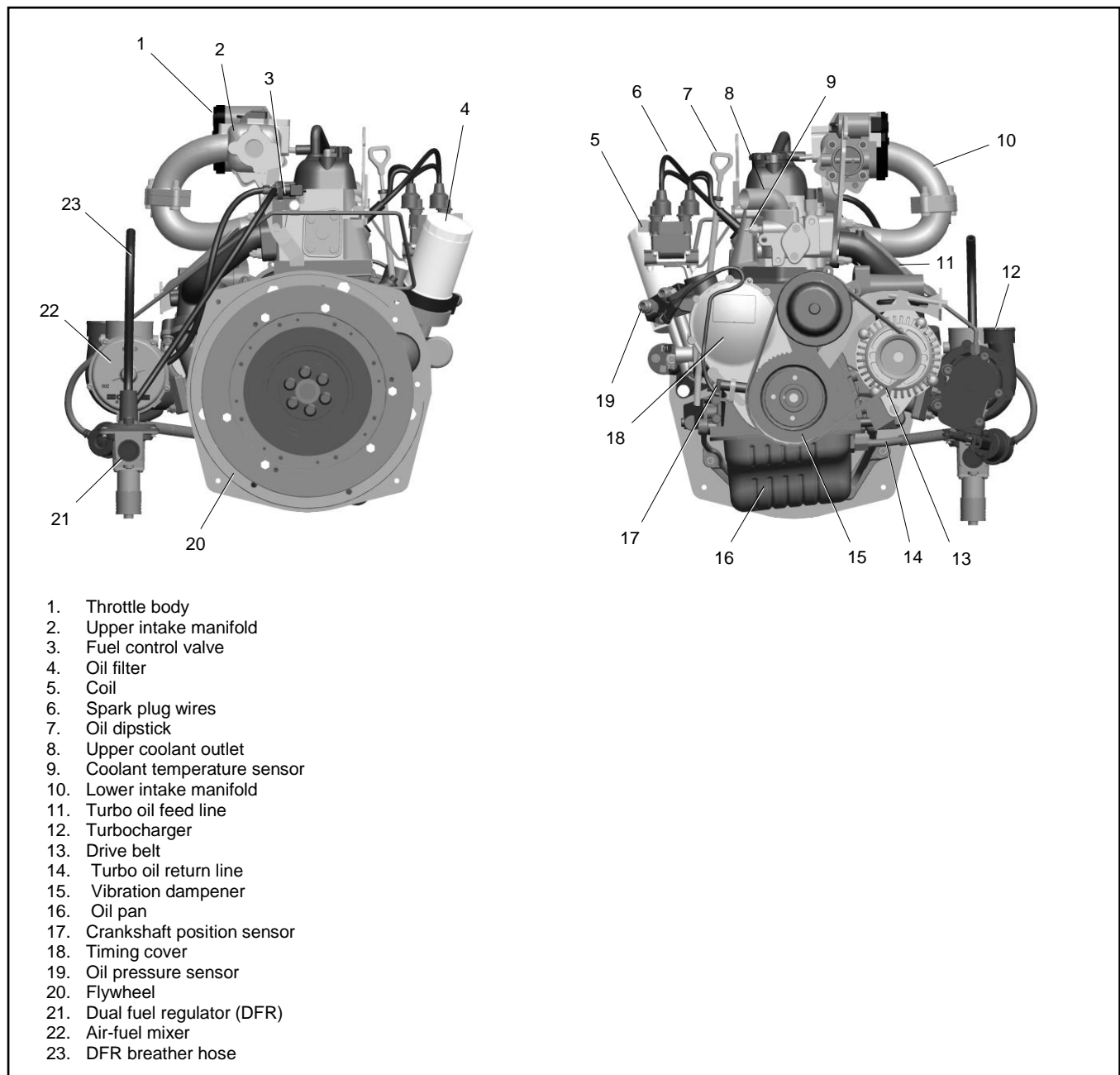

Figure 4 KG2204T Engine Front and Rear Views

### 2.1 Introduction

These four-stroke internal combustion engines are certified to operate on either Propane, Liquid Petroleum Gas (LPG) or Natural Gas (NG). System configuration is factory preset for NG. Instructions for switching to LPG are provided within this section.

The fuel system on this engine is a closed loop design. As the engine runs, sensors located at various points within the system provide continuous operating feedback to the Engine Control Module (ECM). The ECM adjusts the engine speed, ignition timing, and fuel supply in response to changes in the applied load, surrounding air temperature, operating temperature of the engine, and amount of oxygen present in the exhaust.

Refer to the equipment Operation Manual for specific information on how fault codes are displayed.

### 2.2 Fuel System

#### 2.2.1 Components

##### Fuel Shut-Off Valves

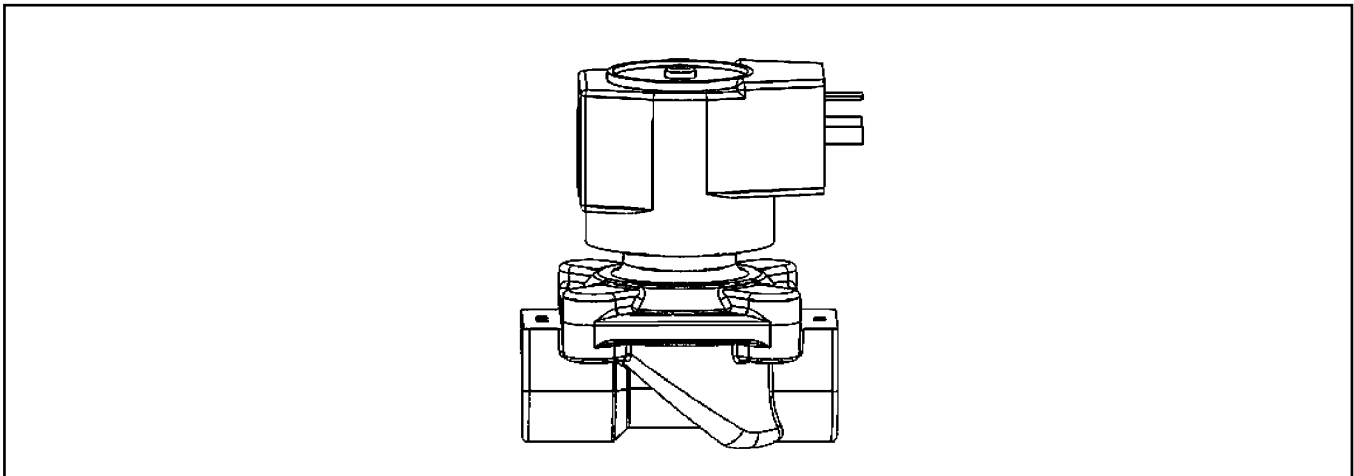

Figure 5 Fuel Shut-Off Valve

The fuel supply contains two fuel shut-off valves located upstream from the fuel connection point on the engine. Each valve consists of a 12V solenoid and a normally closed port. When energized, the solenoid opens the valve and allows the LPG/NG vapor to flow through the system.

The valves are open during the engine cranking and run cycles. Voltage to the valves is controlled by the ECM.

## Fuel Pressure Regulator

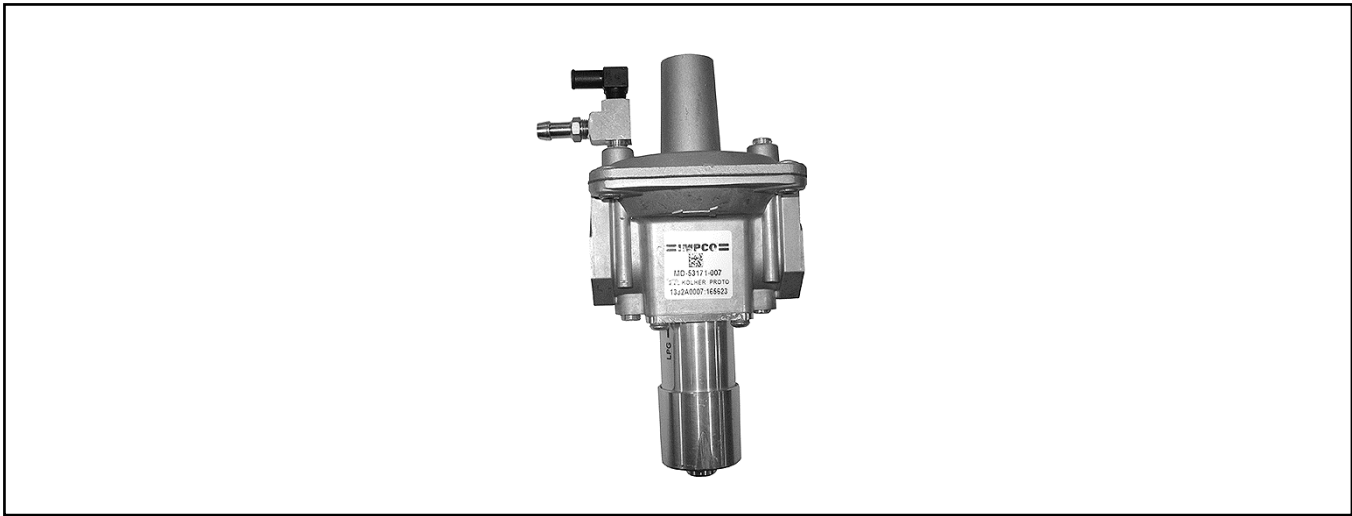

Figure 6 Fuel Pressure Regulator

The fuel pressure regulator modulates the pressure of the LPG/NG vapor to the air-fuel mixer.

The fuel pressure regulator is not adjustable. However, a selector at the base of the regulator is rotated when switching from NG to LPG and back. See the section “NG to LPG Conversion” for instructions.

## Fuel Control Valve

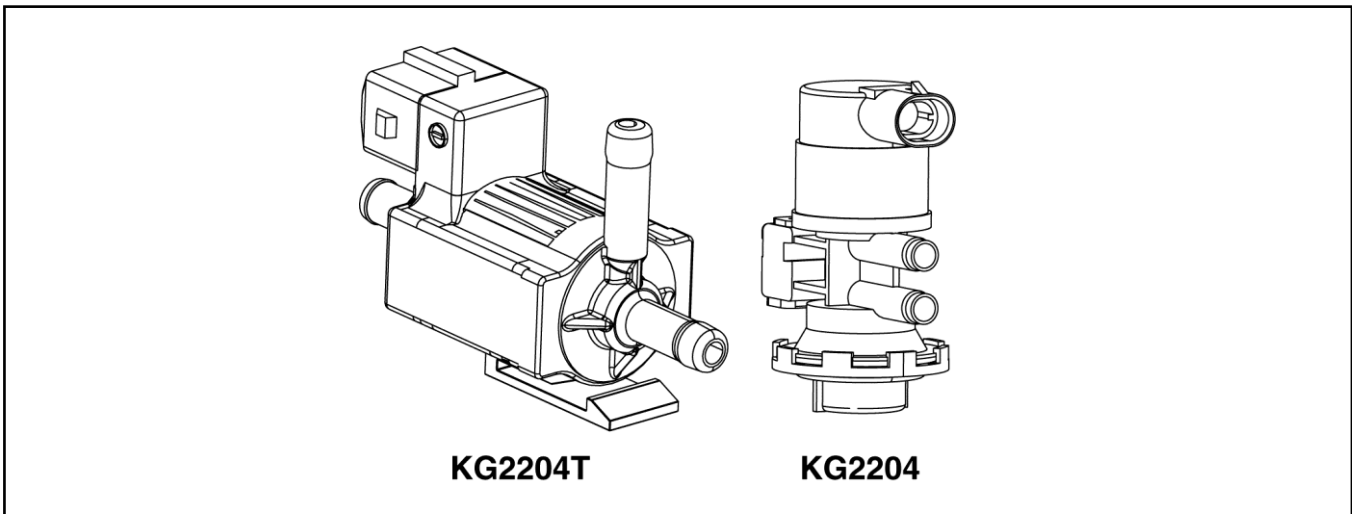

Figure 7 Fuel Control Valve

The fuel control valve is an ECM-controlled vacuum switch that adjusts the fuel pressure delivered from the fuel pressure regulator to the air-fuel mixer.

## Air-Fuel Mixer

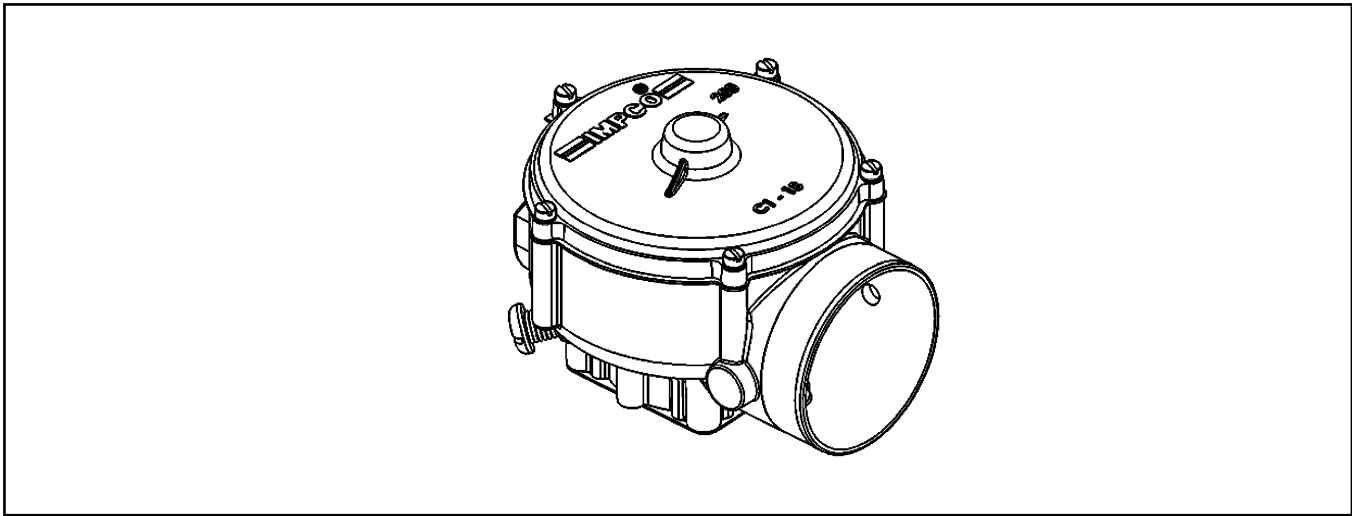

Figure 8 Air-Fuel Mixer

The air-fuel mixer is mounted in the air stream ahead of the throttle. It is a nonadjustable metering device that combines LPG/NG vapor with intake air for combustion.

### NOTICE

Avoid the possibility of component damage. The air-fuel mixer is an emission control device. Components inside the mixer are specifically calibrated to meet the engine's emission requirements and should never be disassembled or rebuilt. If the mixer fails to function correctly, contact your KOHLER authorized distributor or dealer.

## Throttle Body

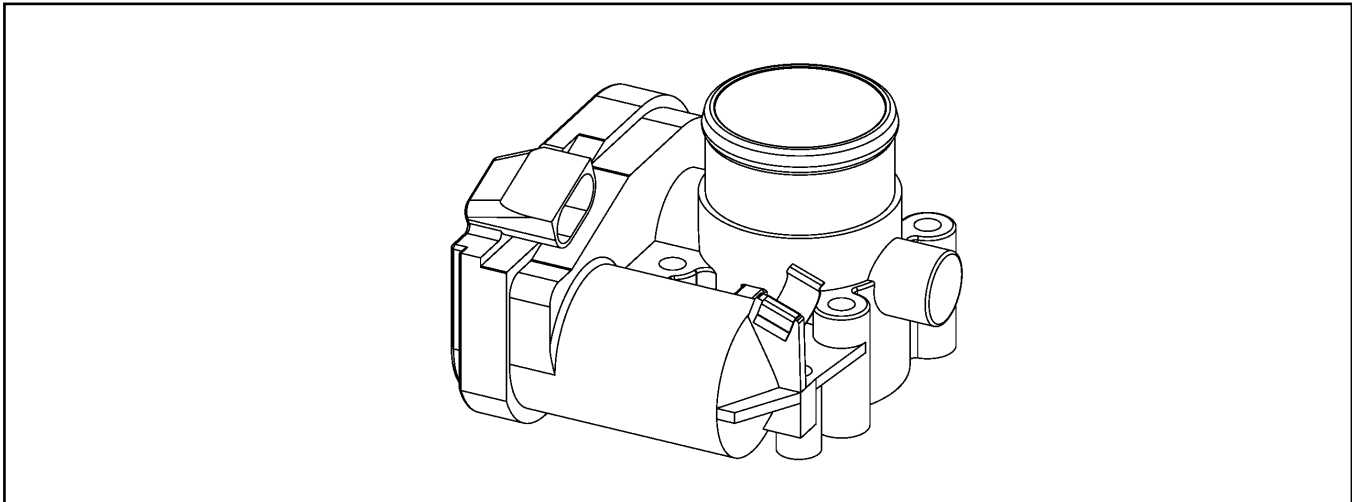

Figure 9 Throttle Body

The throttle body controls the operating speed of the engine according to input from the ECM. Defaults programmed into the ECM software, along with throttle position sensors, allow the ECM to control the overall operation of the engine in response to changing speeds and loads.

## Turbocharger

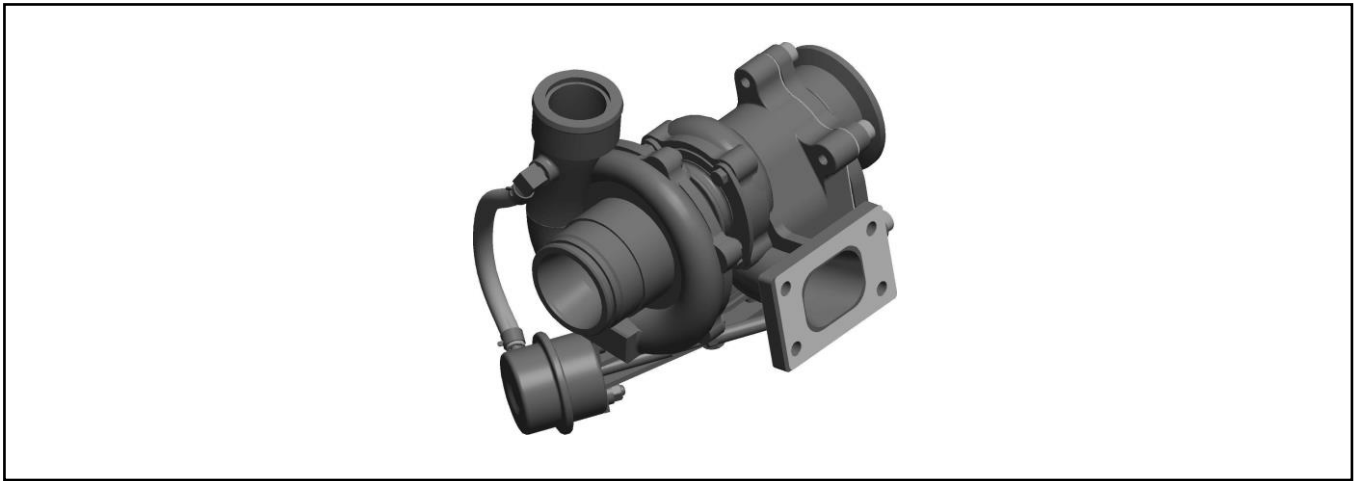

Figure 10 Turbocharger

The Model KG2204T engine is equipped with a turbocharger. The turbocharger utilizes exhaust gas flowing through the turbine to spin a compressor. The turbocharger compressor increases boost pressure and density of the air/fuel mixture entering the intake manifold resulting in higher power output compared to the naturally aspirated engine. A wastegate on the turbocharger bypasses exhaust gas around the turbine when the boost pressure reaches a maximum limit.

## Turbocharger Oil Lines

The Model KG2204T engine is equipped with a turbocharger. The turbocharger bearings require oil for lubrication and cooling. Oil is fed to the turbocharger bearings from the oil supply line on the top side of the bearing housing and returned to the oil sump through a line connecting the bottom side of the bearings to the sump.

## Charge Air Cooler

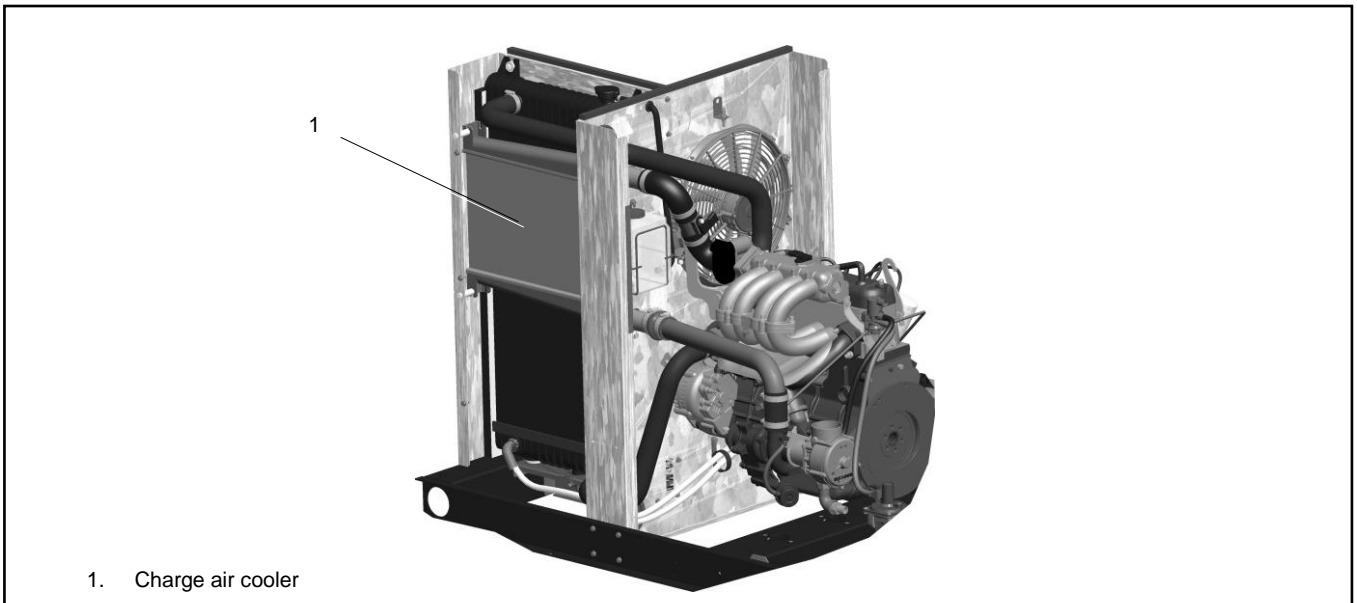

Figure 11 Charge Air Cooler

The Model KG2204T engine is equipped with a charge air cooler. The charge air cooler cools the compressed air/fuel mixture before it enters the intake manifold. The cooler intake manifold charge helps maintain emissions at the high power level of the turbocharged engine.

## Engine Control Module (ECM)

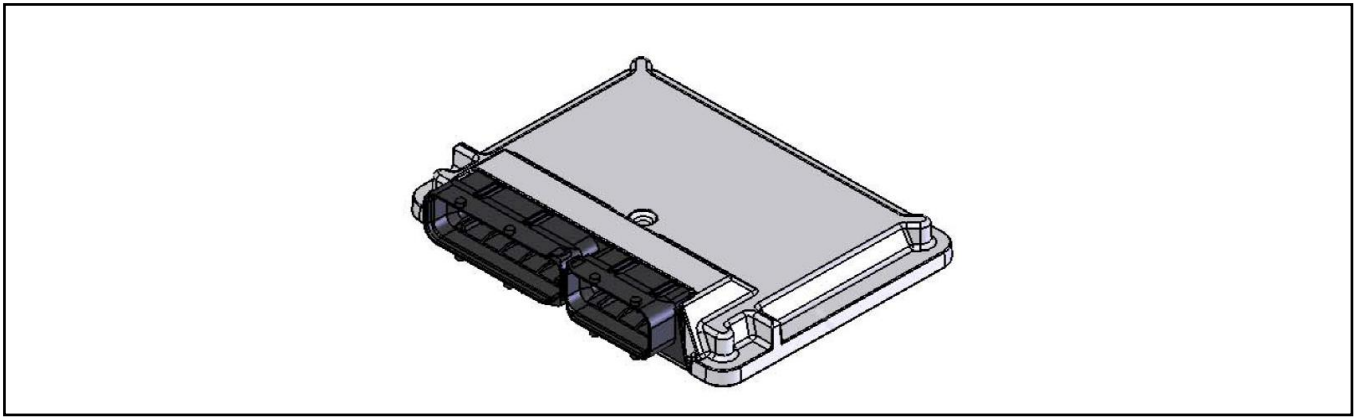

Figure 12 Engine Control Module

The ECM is a digital controller that oversees the various operating parameters of the engine. The ECM receives input data from sensors mounted to the engine and fuel system, and then outputs various signals to adjust engine operation.

The ECM also performs diagnostic functions on the fuel system. If a malfunction occurs, the ECM sends a fault signal to alert the operator to the problem. A corresponding Diagnostic Trouble Code (DTC) is generated and stored in memory within the ECM. A technician can then use a computerized diagnostic scan tool to retrieve the stored DTC number(s) and identify the problem.

## Sensors

### Heated Exhaust Gas Oxygen (HEGO) Sensor

The Heated Exhaust Gas Oxygen (HEGO) sensor measures the amount of oxygen present in the exhaust stream to determine whether the air-fuel ratio is too rich or too lean.

### Air Temperature / Manifold Absolute Pressure (TMAP) Sensor

The Air Temperature / Manifold Absolute Pressure (TMAP) sensor monitors the absolute pressure in the intake manifold. This sensor also measures the temperature of the incoming air. Data returned by the TMAP sensor prompts the ECM to adjust the air-fuel mixture as needed.

### Crankshaft Position Sensor

Crankshaft Position Sensor (CPS) measures the rotary speed and crankshaft turning angle. The ECM ensures the ignition timing for each cylinder depending on the turning signal. The sensor, which consists of a permanent magnet and coil, is installed on the timing gear cover next to the crankshaft pulley. When the crankshaft is turning, the gear ring passes the sensor at different speeds and causes a change of magnet resistance at the sensor to produce a changeable signal.

### Throttle Position Sensor (TPS)

The electronic throttle control device incorporates an internal Throttle Position Sensor (TPS), which provides output signals to the ECM as to the location of the throttle shaft and blade. The ECM will use the signal to monitor and adjust the engine speed.

### Engine Coolant Temperature Sensor

The engine coolant temperature sensor provides engine coolant temperature data to the ECM. The ECM uses this data to adjust for cold starting conditions, and regulates various fuel and emission control functions.

### Engine Oil Pressure Sender

The engine oil pressure sender ensures sufficient lubrication throughout the engine. The sender is a pressure valve that is monitored by the ECM. A drop in pressure will trigger a fault code.

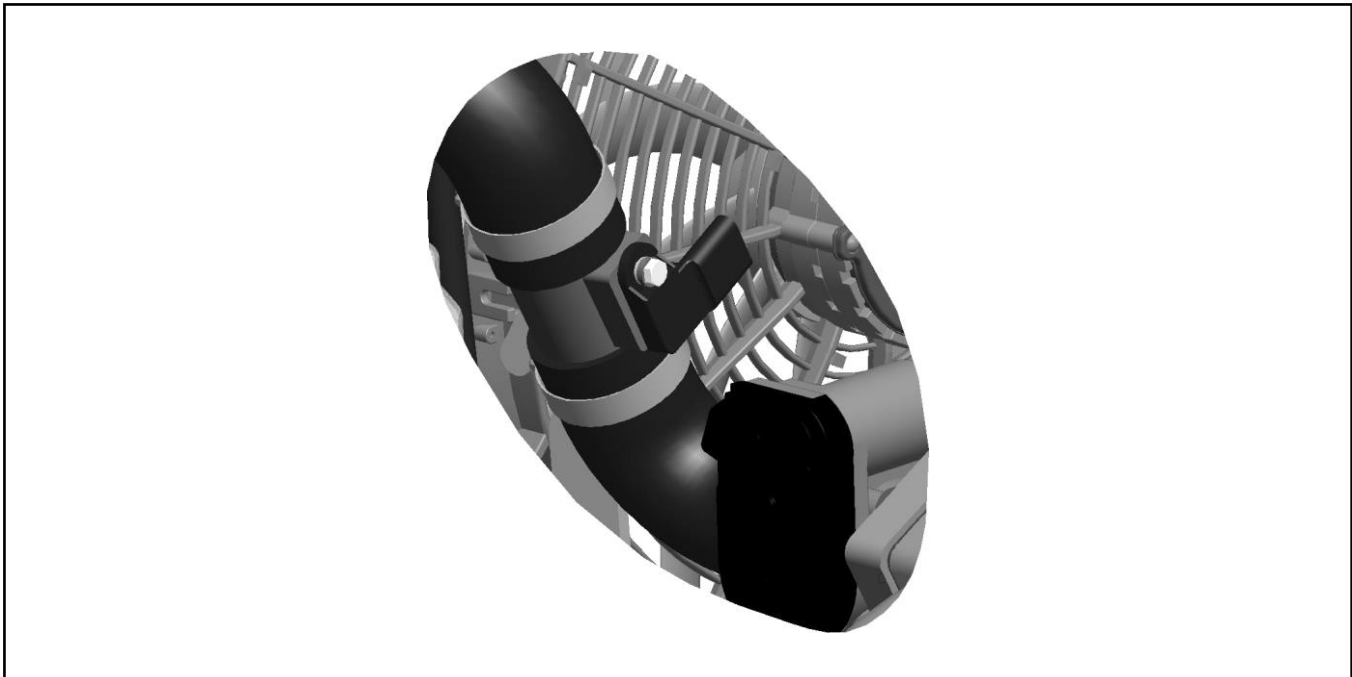

Figure 13 Throttle Manifold Air Pressure (MAP) Sensor

**Up-Stream Throttle Manifold Air Pressure (MAP) Sensor (KG2204T)**

The Up-stream Throttle Manifold Air Pressure sensor monitors the absolute pressure in the air induction system up-stream of the throttle. Data returned by the MAP sensor prompts the ECM to adjust the air-fuel mixture as needed.



## 2.2.2 Fuel Specifications

<b>NOTICE</b>	
Natural gas and propane installations must be installed in accordance with applicable federal, state, and local law, and with the National Fire Protection Association (NFPA) Pamphlet #58, standard for storage and handling of Liquefied Petroleum Gases, to the extent that these standards are not in violation of federal, state, or local law.	

Fuel Type	Item	Specification	
		KG2204	KG2204T
<b>Liquid Propane Gas (LPG)</b>	Type	HD-5 or HD-10	
	Maximum fuel pressure (engine OFF, no load), kPa (in. H <sup>2</sup> O)	2.74 (11.0)	
	Minimum fuel pressure (engine ON, full load), kPa (in. H <sup>2</sup> O)	1.7 (7.0)	
<b>Natural Gas (NG)</b>	Supply	Standard pipeline	
	Approximate supply volume, kJ/m <sup>3</sup> (BTU/ft <sup>3</sup> )	37.257 (1000)	
	Minimum flow, m <sup>3</sup> /hr. (SCFH) @ 5 in. H <sup>2</sup> O	11.9 (420)	19.6 (690)
	Allowable water vapor, Less than kg per 1 million m <sup>3</sup> (Less than lb. per 1 million ft. <sup>3</sup> )	112.3 (7)	
	Maximum fuel pressure (engine OFF, no load), kPa (in. H <sup>2</sup> O)	2.74 (11.0)	
	Minimum fuel pressure (engine ON, full load), kPa (in. H <sup>2</sup> O)	1.7 (7.0)	
<b>LPG and NG (both)</b>	Fuel handling and supply component constraints	UL 2200: Standard for Stationary Engine Equipment Assemblies	
	Operating temperature range °C (°F)	-20–105 (-4–221)	

Table 14 Fuel Specifications

### 2.2.3 NG to LPG Conversion

The engines are easily configurable for use with either NG or LPG. System configuration for NG or LPG requires a mechanical setting on the fuel pressure regulator and an electrical setting change at the ECM. These adjustments will ensure that the proper fuel and spark timing is supplied to the engine.

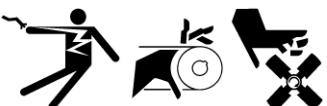

**Note:**

The fuel pressure regulator is factory preset for NG. When using NG, no mechanical adjustment is required.

 <b>WARNING</b>	<p><b>Accidental starting.</b>  <b>Can cause severe injury or death.</b></p> <p>Disconnect the battery cables before working on the engine. Remove the negative (-) lead first when disconnecting the battery. Reconnect the negative (-) lead last when reconnecting the battery.</p>
	

**Disabling the engine. Accidental starting can cause severe injury or death.** Before working on the engine or connected equipment, disable the engine as follows: 1) Disconnect the ignition coil. 2) Remove the battery cables, negative (-) lead first. Reconnect the negative (-) lead last when reconnecting the battery. Follow these precautions to prevent the accidental starting of the engine.

 <b>WARNING</b>	<p><b>Risk of fire.</b>  <b>Can cause severe injury or death.</b></p> <p>Do not smoke or permit flames or sparks near fuels or the fuel system.</p>
	

 <b>WARNING</b>	<p><b>Explosive fuel vapors.</b>  <b>Can cause fires and severe burns.</b></p> <p>If a gaseous odor is detected, ventilate the area and contact an authorized service technician.</p>
	

**The fuel system. Explosive fuel vapors can cause severe injury or death.** Vaporized fuels are highly explosive. Use extreme care when handling and storing fuels. Store fuels in a well-ventilated area away from spark-producing equipment and out of the reach of children. Never add fuel to the tank while the engine is running because spilled fuel may ignite on contact with hot parts or from sparks. Do not smoke or permit flames or sparks to occur near sources of spilled fuel or fuel vapors. Keep the fuel lines and connections tight and in good condition. Do not replace flexible fuel lines with rigid lines. Use flexible sections to avoid fuel line breakage caused by vibration. Do not operate the engine in the presence of fuel leaks, fuel accumulation, or sparks. Repair fuel systems before resuming engine operation.

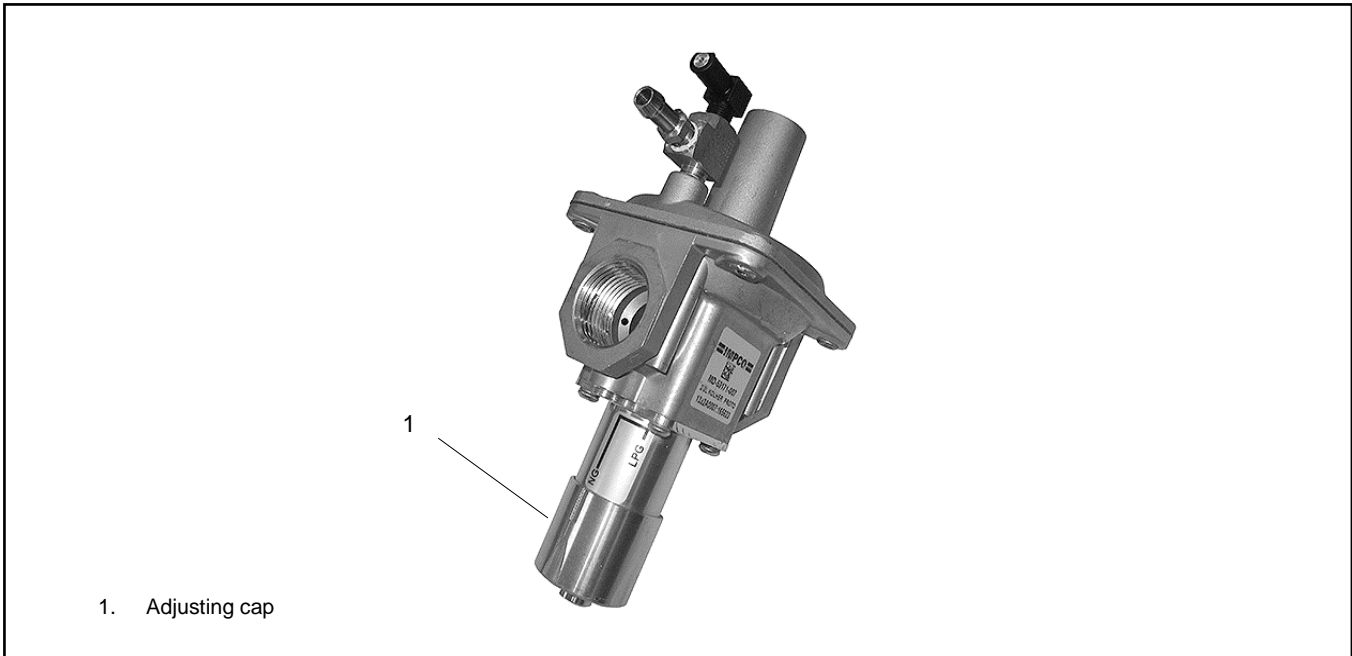

1. Adjusting cap

Figure 15 Regulator

**To set the regulator for LPG:**

1. Push the adjusting cap to its upper stop and rotate clockwise, release upward pressure, and lock into place. See Figure 15.
2. **For LPG fuel only**, connect wire N20 from the fuel pressure regulator to wire 45 from the ECM wiring harness using the quick-connect adapters. See Figure 16 **Error! Reference source not found.**

**To reset the regulator for NG:**

1. Reverse the above procedure to reset for NG operation.
2. Push up on the adjusting cap and rotate counterclockwise. Release upward pressure, and lock into place. See Figure 15.
3. Disconnect wire N20 and wire 45. See Figure 16.

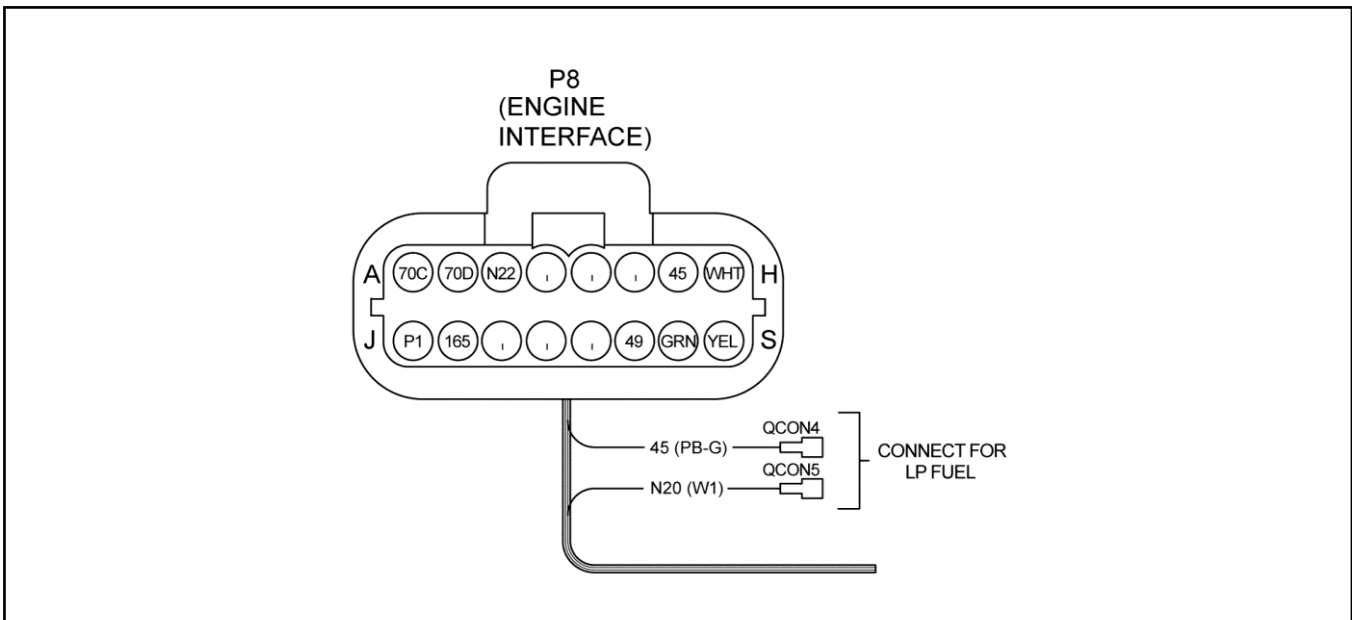

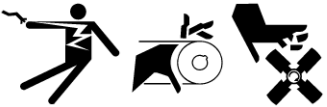

Figure 16 Wiring Harness

## 2.3 Before Starting

 <b>WARNING</b>	<b>Accidental starting.</b> <b>Can cause severe injury or death.</b> Disconnect the battery cables before working on the engine. Remove the negative (-) lead first when disconnecting the battery. Reconnect the negative (-) lead last when reconnecting the battery.
	



**Disabling the engine. Accidental starting can cause severe injury or death.** Before working on the engine or connected equipment, disable the engine as follows: 1) Disconnect the ignition coil. 2) Remove the battery cables, negative (-) lead first. Reconnect the negative (-) lead last when reconnecting the battery. Follow these precautions to prevent the accidental starting of the engine.

To prevent possible injury or damage to equipment, carefully read and understand all information in this Operation Manual before starting the engine. Follow the checklist below prior to each start up:



- Perform a walk-around inspection, checking for damage, fluid leaks, loose or missing fasteners, or debris.
- Check pipe and hose connections to make sure that they are tight.
- Check drive-belt tension and adjust as needed. See "Ignition Timing."
- Check engine oil level; add oil as needed. Inspect engine oil for signs of deterioration or contamination. See "Check Engine Oil."
- Check engine coolant level; add coolant as needed. Inspect coolant for contamination. See "Check Coolant Level and Condition."
- Check battery connections to ensure that they are tight with no visible corrosion. Check level of battery electrolyte and add fluid if necessary. See "Electrical System."
- Check and clean cooling areas, air intake areas, and external surfaces of the engine, particularly if the engine has been stored for a long period of time.
- Check to make sure that air cleaner components, shrouds, equipment covers, and guards are in place and securely fastened.
- Check all electrical connections to make sure that they are tight, including those at the alternator, starter, spark plug, and ignition coil. Repair damaged or loose wires or connectors before starting the engine.
- Check the fuel system. Make sure that all connections are secure at the fuel supply line and at all fuel system components. **Do not start the engine if you can smell leaking gas.**
- LPG only: check the fuel level in the fuel tank, and refill if necessary.

## 2.4 Starting



The specific engine starting sequence varies depending on the equipment that this engine powers. For more information, refer to the Operation Manual for the equipment using this engine.

 <b>WARNING</b>	<b>Carbon monoxide.</b> <b>Can cause severe nausea, fainting, or death.</b> The exhaust system must be leakproof and routinely inspected.
	

**Engine Operation. Carbon monoxide can cause severe nausea, fainting, or death.** Engine exhaust gases contain poisonous carbon monoxide. Carbon monoxide is an odorless, colorless, tasteless, nonirritating gas that can cause death if inhaled for even a short time. Avoid breathing exhaust fumes when working on or near the engine. Never operate the engine inside a building. Never operate the engine where exhaust gas could seep inside or be drawn into a potentially occupied building through windows, air intake vents, or other openings.

 <b>WARNING</b>	<b>Moving parts.</b> <b>Can cause severe injury or death.</b> Operate the engine only when all guards and electrical enclosures are in place. Stay away from moving parts while the engine is in operation.
	

**Servicing the engine when it is operating. Exposed moving parts can cause severe injury or death.** Keep hands, feet, hair, clothing, and test leads away from the belts and pulleys when the engine is running. Replace guards, screens, and covers before operating the engine.



 <b>WARNING</b>	<b>Explosive fuel vapors.</b> <b>Can cause fires and severe burns.</b> If a gaseous odor is detected, ventilate the area and contact an authorized service technician.
	



**The fuel system. Explosive fuel vapors can cause severe injury or death.** Vaporized fuels are highly explosive. Use extreme care when handling and storing fuels. Store fuels in a well-ventilated area away from spark-producing equipment and out of the reach of children. Never add fuel to the tank while the engine is running because spilled fuel may ignite on contact with hot parts or from sparks. Do not smoke or permit flames or sparks to occur near sources of spilled fuel or fuel vapors. Keep the fuel lines and connections tight and in good condition. Do not replace flexible fuel lines with rigid lines. Use flexible sections to avoid fuel line breakage caused by vibration. Do not operate the engine in the presence of fuel leaks, fuel accumulation, or sparks. Repair fuel systems before resuming engine operation.

If the engine does not start after 5 seconds of cranking, wait at least 15 seconds before trying again. Do not crank the starter longer than three crank cycles. After three crank cycles, the controller will display faults. Longer crank times can overheat the starter and drain the battery.

If the engine does not start after three attempts, discontinue the starting procedure. Perform troubleshooting to locate the problem(s) and correct them before trying again.

## 2.5 Cold Weather Starting

 <b>WARNING</b>	<b>Handling caustic engine fluids and chemical products.</b> <b>Can cause severe chemical burns, nausea, fainting, or death.</b>
	Most chemicals such as used engine oil, antifreeze/coolant, rustproofing agent, inhibiting oil, degreasing agent, spray paint, and adhesives are hazardous to health. Read and follow the user information found on the packaging. Avoid inhalation and skin contact. Use only in well-ventilated areas and use a protective mask when spraying. Store engine fluids and chemical products in a locked cabinet. Contact your local recycling center for disposal information and locations.



 <b>WARNING</b>	<b>Explosive fuel vapors.</b> <b>Can cause fires and severe burns.</b>
	If a gaseous odor is detected, ventilate the area and contact an authorized service technician.

**The fuel system. Explosive fuel vapors can cause severe injury or death.** Vaporized fuels are highly explosive. Use extreme care when handling and storing fuels. Store fuels in a well-ventilated area away from spark-producing equipment and out of the reach of children. Never add fuel to the tank while the engine is running because spilled fuel may ignite on contact with hot parts or from sparks. Do not smoke or permit flames or sparks to occur near sources of spilled fuel or fuel vapors. Keep the fuel lines and connections tight and in good condition. Do not replace flexible fuel lines with rigid lines. Use flexible sections to avoid fuel line breakage caused by vibration. Do not operate the engine in the presence of fuel leaks, fuel accumulation, or sparks. Repair fuel systems before resuming engine operation.



Cold weather puts added stress on the engine during start up. To start the engine in cold weather:

- Make sure that the engine oil is appropriate for the ambient operating temperature. See the maintenance section for fluid specifications. Drain and replace the engine oil if necessary.
- Disconnect all applied loads and/or equipment before cranking the starter.
- Allow the engine to run, unloaded, for about 5 minutes after cold weather start up.

## 2.6 Monitoring Engine Operation

 <b>WARNING</b>	<b>Carbon monoxide.</b> <b>Can cause severe nausea, fainting, or death.</b> Avoid inhaling exhaust fumes.
	

**Engine Operation. Carbon monoxide can cause severe nausea, fainting, or death.** Engine exhaust gases contain poisonous carbon monoxide. Carbon monoxide is an odorless, colorless, tasteless, nonirritating gas that can cause death if inhaled for even a short time. Avoid breathing exhaust fumes when working on or near the engine. Never operate the engine inside a building. Never operate the engine where exhaust gas could seep inside or be drawn into a potentially occupied building through windows, air intake vents, or other openings.

 <b>CAUTION</b>	<b>Hazardous voltage.</b> <b>Electrical shock can cause injury.</b> Do not touch wires while the engine is running. Stop the engine and disconnect the battery leads, negative (-) lead first, before servicing the engine.
	

Check for the following items as the engine runs.

- **Gas/air leaks:** check for leakage from fuel pipes, cooling pipes, or air pipes.
- **Exhaust:** check for detonation, backfire, or knocking. Watch for excessive smoke or abnormal color.
- **Noise:** listen for rattles or other abnormal noise.
- **Electrical:** check for burnt smell from hot electrical equipment.
- **Fluid leaks:** check for leaking oil or coolant.
- **Gauges:** check oil pressure, coolant temperature, and other operating parameters.

If any abnormal or unusual conditions are detected, stop the engine immediately and perform troubleshooting diagnostics before resuming operation.

## 2.7 Stopping

1. Disconnect all applied loads if possible, along with power take-off (PTO) attachments, before stopping the engine.
2. If the engine has been running under a heavy load, reduce engine speed and allow it to run for an additional 2-3 minutes before stopping. This action will help to cool the engine slightly before shutdown.

The specific engine-stopping sequence varies depending on the equipment that this engine powers. For more information, refer to the Operation Manual for the equipment using this engine.





### 3.1 Introduction



Preventive maintenance is critical to prolonging the life of the engine and keeping it in optimum working condition. As the engine runs, fasteners may loosen, parts may become worn, clearances change, and oil picks up dirt and contaminants. The engine may eventually become hard to start, or may exhibit other symptoms such as decreased power output or increased fuel consumption.

Regularly scheduled maintenance will help to prevent or reduce the impact of these performance issues. To keep the engine working reliably, perform all preventive maintenance tasks described in this section.

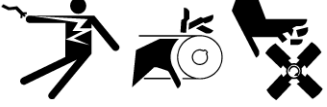

### 3.2 Safety Precautions and Instructions

 <b>WARNING</b>	<p><b>Accidental starting.</b> <b>Can cause severe injury or death.</b></p> <p>Disconnect the battery cables before working on the engine. Remove the negative (-) lead first when disconnecting the battery. Reconnect the negative (-) lead last when reconnecting the battery.</p>
	



**Disabling the engine. Accidental starting can cause severe injury or death.** Before working on the engine or connected equipment, disable the engine as follows: 1) Disconnect the ignition coil. 2) Remove the battery cables, negative (-) lead first. Reconnect the negative (-) lead last when reconnecting the battery. Follow these precautions to prevent the accidental starting of the engine.



 <b>WARNING</b>	<p><b>Handling caustic engine fluids and chemical products.</b> <b>Can cause severe chemical burns, nausea, fainting, or death.</b></p> <p>Most chemicals such as used engine oil, antifreeze/coolant, rustproofing agent, inhibiting oil, degreasing agent, spray paint, and adhesives are hazardous to health. Read and follow the user information found on the packaging. Avoid inhalation and skin contact. Use only in well-ventilated areas and use a protective mask when spraying. Store engine fluids and chemical products in a locked cabinet. Contact your local recycling center for disposal information and locations.</p>
	

**Used engine oil. Contact with used engine oil may cause severe skin irritation. Repeated and prolonged skin exposure may have other health risks.** Used engine oil is a suspected carcinogen. Avoid contact with skin. Thoroughly wash your hands and nails with soap and water shortly after handling used engine oil. Wash or dispose of clothing or rags containing used engine oil. Dispose of used engine oil in a responsible manner. Contact your local recycling center for disposal information and locations.



 <b>WARNING</b>	<p><b>Hot engine and exhaust system.</b> <b>Can cause severe injury or death.</b></p> <p>Do not work on the engine until it cools.</p>
	



**Servicing the exhaust system. Hot parts can cause severe injury or death.** Do not touch hot engine parts. The engine and exhaust system components become extremely hot during operation.

 <b>WARNING</b>	<p><b>Hot coolant and steam.</b> <b>Can cause severe injury or death.</b></p> <p>Before removing the pressure cap, stop the engine and allow it to cool. Then loosen the pressure cap to relieve pressure.</p>
	

 <b>CAUTION</b>	<b>Hazardous voltage.</b> <b>Electrical shock can cause injury.</b>
	Do not touch wires while the engine is running. Stop the engine and disconnect the battery leads, negative (-) lead first, before servicing the engine.

**Servicing the engine when it is operating. Exposed moving parts can cause severe injury or death.** Keep hands, feet, hair, clothing, and test leads away from the belts and pulleys when the engine is running. Replace guards, screens, and covers before operating the engine.

 <b>WARNING</b>	<b>Moving parts.</b> <b>Can cause severe injury or death.</b>
	Operate the engine only when all guards and electrical enclosures are in place. Stay away from moving parts while the engine is in operation.

 <b>WARNING</b>	<b>Explosive fuel vapors.</b> <b>Can cause severe injury or death.</b>
	Use extreme care when handling, storing, and using fuels.

**The fuel system. Explosive fuel vapors can cause severe injury or death.** Vaporized fuels are highly explosive. Use extreme care when handling and storing fuels. Store fuels in a well-ventilated area away from spark-producing equipment and out of the reach of children. Never add fuel to the tank while the engine is running because spilled fuel may ignite on contact with hot parts or from sparks. Do not smoke or permit flames or sparks to occur near sources of spilled fuel or fuel vapors. Keep the fuel lines and connections tight and in good condition. Do not replace flexible fuel lines with rigid lines. Use flexible sections to avoid fuel line breakage caused by vibration. Do not operate the engine in the presence of fuel leaks, fuel accumulation, or sparks. Repair fuel systems before resuming engine operation.

**Gas fuel leaks. Explosive fuel vapors can cause severe injury or death.** Fuel leakage can cause an explosion. Check the LPG vapor or natural gas fuel system for leakage by using a soap and water solution with the fuel system test pressurized to 6–8 ounces per square inch (10–14 inches water column). Do not use a soap solution containing either ammonia or chlorine because both prevent bubble formation. A successful test depends on the ability of the solution to bubble.

**LPG liquid withdrawal fuel leaks. Explosive fuel vapors can cause severe injury or death.** Fuel leakage can cause an explosion. Check the LPG liquid withdrawal fuel system for leakage by using a soap and water solution with the fuel system test pressurized to at least 90 psi (621 kPa). Do not use a soap solution containing either ammonia or chlorine because both prevent bubble formation. A successful test depends on the ability of the solution to bubble.

### 3.3 Fluid Specifications

#### 3.3.1 Oil Recommendations

**Note:**

- Do not mix different brands or types of oil.
- Do not overfill or underfill the engine's lubrication system. See "Engine Specifications."

Use oil that displays the American Petroleum Institute (API) Starburst certification mark FOR GASOLINE ENGINES on the container. Do not use straight-weight oils recommended for industrial or stationary engines. CC or CD classification oils, even when labeled HEAVY DUTY or For Natural Gas Engines are not acceptable.

Multi-viscosity synthetic oils are recommended. For best performance in colder environments (such as the United States and Canada), use Society of Automotive Engineers (SAE) 5W-30, API service class SJ or higher. In extremely hot environments where temperatures are never or rarely below 0°C (32°F), use a synthetic oil with a viscosity designation of 10W-30, API service class SJ or higher.

#### 3.3.2 Grease Recommendations

The alternator and starter bearings on this engine must be lubricated with high-quality lithium-based automotive grease.

#### 3.3.3 Coolant Recommendations

Use only a mixture of 50% long life coolant and 50% clean, softened water to inhibit rust/corrosion and prevent freezing.

A solution of 50% long life coolant provides freezing protection to -37°C (-34°F) and overheating protections to 149°C (300°F). A coolant solution with less than 50% long life coolant may not provide adequate freezing and overheating protection. Do not mix long life coolants and conventional coolants. **Do not mix different types and/or colors of long life coolants.**

### 3.4 Periodic Maintenance Schedule

Engine parts experience wear at different rates. Technical maintenance tasks, therefore, are required at different intervals throughout the life of the engine. Tasks performed after the first 10 hours of operation, for example, must be repeated after 20 hours, 30 hours, and so forth. Perform and repeat these tasks according to the periodic schedule below.

<b>Daily (before starting)</b>
<ul style="list-style-type: none"> <li>• Check for loose or missing fasteners. Tighten or replace as needed.</li> </ul>
<ul style="list-style-type: none"> <li>• Check the level of fuel, coolant, and oil. Refill as needed.</li> </ul>
<ul style="list-style-type: none"> <li>• Check coolant system hoses and clamps.</li> </ul>
<b>Weekly or every 10 hours of operation</b>
<ul style="list-style-type: none"> <li>• Check battery connections for tightness and signs of corrosion.</li> </ul>
<ul style="list-style-type: none"> <li>• Check for oil and coolant leaks.</li> </ul>
<ul style="list-style-type: none"> <li>• Check wiring and electrical connections. Repair or replace loose or damaged components.</li> </ul>
<ul style="list-style-type: none"> <li>• Start engine and listen for abnormal noises.</li> </ul>
<ul style="list-style-type: none"> <li>• Check for fuel system leaks, hissing sounds, or gas odor.</li> </ul>
<b>Quarterly or every 20 hours of operation</b>
<ul style="list-style-type: none"> <li>• Check battery voltage; charge or replace as needed.</li> </ul>
<ul style="list-style-type: none"> <li>• Check and clean air filter. (See equipment Operation Manual.)</li> </ul>
<ul style="list-style-type: none"> <li>• Check all fasteners for tightness.</li> </ul>
<b>Yearly or every 120 hours of operation</b>
<ul style="list-style-type: none"> <li>• Check the battery for cracks, damaged electrodes, and corrosion.</li> </ul>
<ul style="list-style-type: none"> <li>• Check the drive-belt tension. Adjust or replace drive belt if necessary.</li> </ul>
<ul style="list-style-type: none"> <li>• Replace engine oil and oil filter.</li> </ul>
<b>3 years or every 400 hours of operation</b>
<ul style="list-style-type: none"> <li>• Change air filter element(s). (See equipment Operation Manual.)</li> </ul>
<b>3 years or every 500 hours of operation</b>
<ul style="list-style-type: none"> <li>• Check spark plug condition and electrode gap. Adjust gap if necessary. Replace spark plug(s) if discolored or damaged.</li> </ul>
<b>Seasonal Maintenance</b>
<ul style="list-style-type: none"> <li>• Check coolant concentration and replenish/replace as needed.</li> </ul>
<ul style="list-style-type: none"> <li>• Replace engine oil with a lower temperature grade in the winter (if required).</li> </ul>

## 3.5 Engine

### 3.5.1 Check Engine Oil

Check the engine oil level daily before starting the engine. Inspect the oil for signs of deterioration, discoloration, thinning, or water contamination. If any of these conditions exist, the oil quality has been compromised and should be replaced.

#### Required materials:

- Clean, dry cloth.
- Fresh engine oil. (See the section “Oil Recommendations”)

#### Procedure:

1. Stop the engine and allow it to cool.

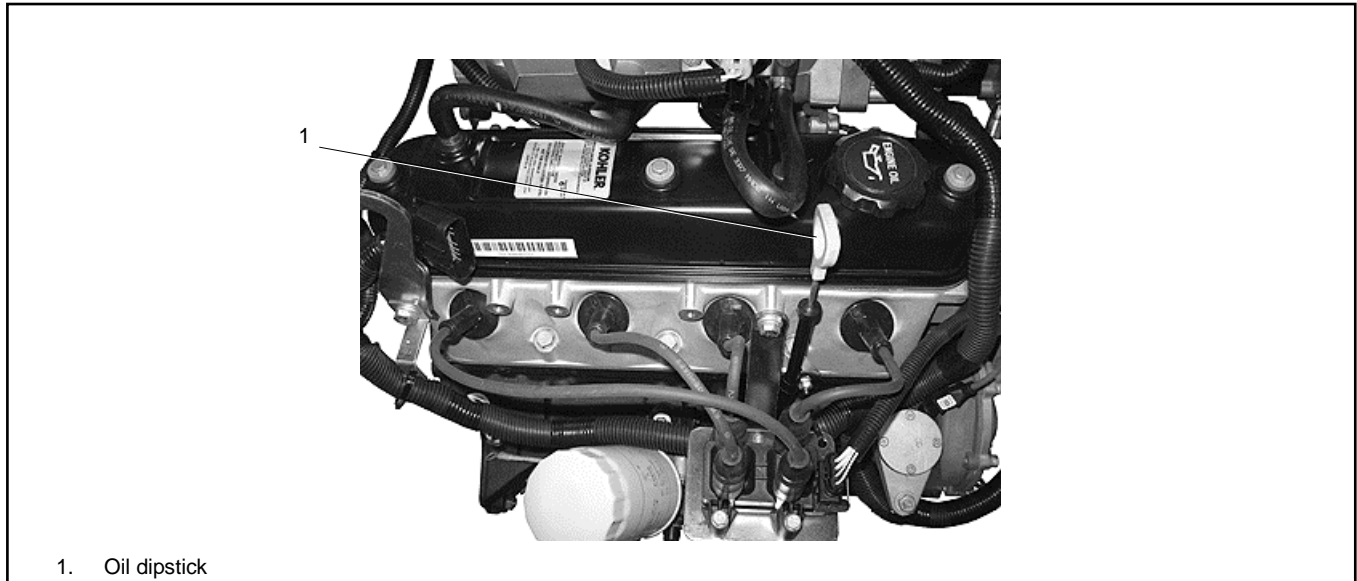

Figure 17 Oil Dipstick Location

2. Pull out the oil dipstick. See Figure 17.
3. Wipe the end of the dipstick with a clean, dry cloth.
4. Insert the dipstick into the engine.

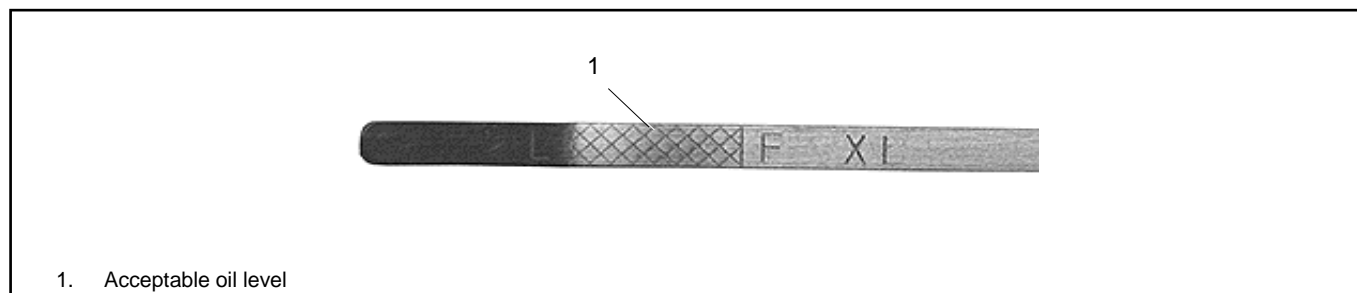
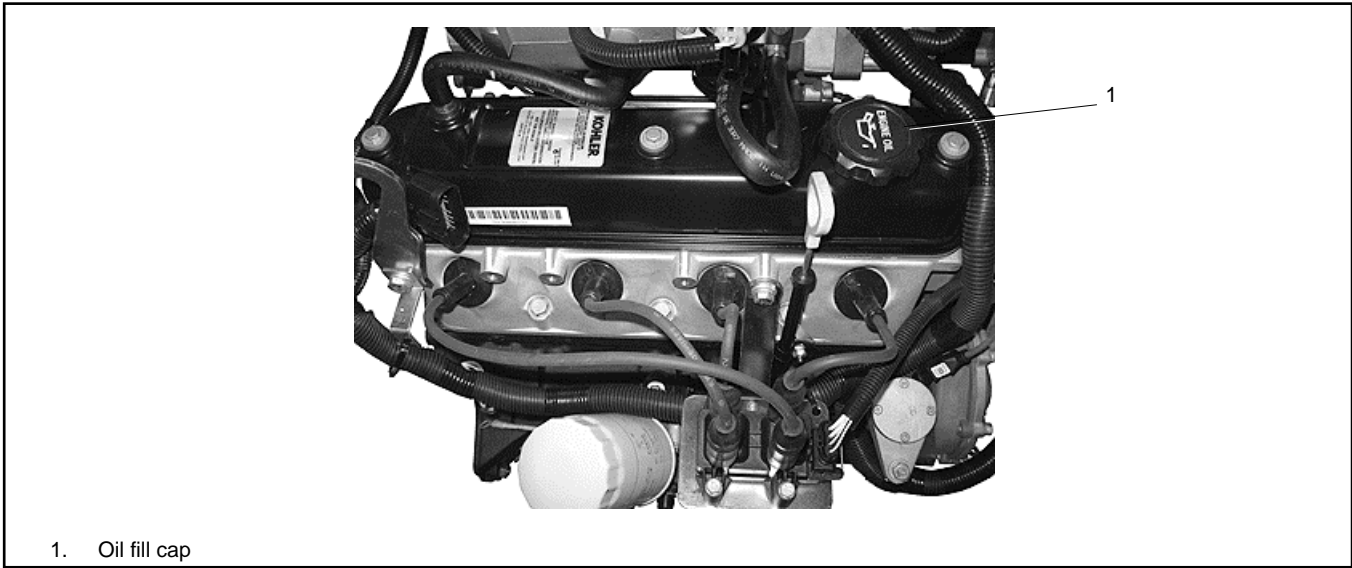

Figure 18 Oil Dipstick

5. Pull out the dipstick again to check the oil level. The oil level should be maintained between the F (full) and L (low) marks. See Figure 18.



1. Oil fill cap

Figure 19 Oil Fill Cap



6. If the oil level is below L, check for leaks. If no leaks are found, open the oil fill cap. Wipe the oil fill cap clean, and add oil up to the F mark. See Figure 19.
7. If oil leaks are found, repair them before operating the engine.

### 3.5.2 Change Engine Oil and Oil Filter

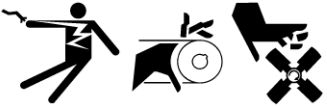

Change the engine oil and filter every 120 hours of operation. Replace the engine oil and filter more often if the machine is being run in excessively dirty or dusty conditions.

 <b>WARNING</b>	<p><b>Accidental starting.</b>  <b>Can cause severe injury or death.</b></p> <p>Disconnect the battery cables before working on the engine. Remove the negative (-) lead first when disconnecting the battery. Reconnect the negative (-) lead last when reconnecting the battery.</p>
	



**Disabling the engine. Accidental starting can cause severe injury or death.** Before working on the engine or connected equipment, disable the engine as follows: 1) Disconnect the ignition coil. 2) Remove the battery cables, negative (-) lead first. Reconnect the negative (-) lead last when reconnecting the battery. Follow these precautions to prevent the accidental starting of the engine.

 <b>WARNING</b>	<p><b>Handling caustic engine fluids and chemical products.</b>  <b>Can cause severe chemical burns, nausea, fainting, or death.</b></p> <p>Most chemicals such as used engine oil, antifreeze/coolant, rustproofing agent, inhibiting oil, degreasing agent, spray paint, and adhesives are hazardous to health. Read and follow the user information found on the packaging. Avoid inhalation and skin contact. Use only in well-ventilated areas and use a protective mask when spraying. Store engine fluids and chemical products in a locked cabinet. Contact your local recycling center for disposal information and locations.</p>
	

**Used engine oil. Contact with used engine oil may cause severe skin irritation. Repeated and prolonged skin exposure may have other health risks.** Used engine oil is a suspected carcinogen. Avoid contact with skin. Thoroughly wash your hands and nails with soap and water shortly after handling used engine oil. Wash or dispose of clothing or rags containing used engine oil. Dispose of used engine oil in a responsible manner. Contact your local recycling center for disposal information and locations.

 <b>WARNING</b>	<p><b>Explosive fuel vapors.</b>  <b>Can cause fires and severe burns.</b></p> <p>If a gaseous odor is detected, ventilate the area and contact an authorized service technician.</p>
	

**The fuel system. Explosive fuel vapors can cause severe injury or death.** Vaporized fuels are highly explosive. Use extreme care when handling and storing fuels. Store fuels in a well-ventilated area away from spark-producing equipment and out of the reach of children. Never add fuel to the tank while the engine is running because spilled fuel may ignite on contact with hot parts or from sparks. Do not smoke or permit flames or sparks to occur near sources of spilled fuel or fuel vapors. Keep the fuel lines and connections tight and in good condition. Do not replace flexible fuel lines with rigid lines. Use flexible sections to avoid fuel line breakage caused by vibration. Do not operate the engine in the presence of fuel leaks, fuel accumulation, or sparks. Repair fuel systems before resuming engine operation.

 <b>WARNING</b>	<p><b>Hot engine and exhaust system.</b>  <b>Can cause severe injury or death.</b></p> <p>Do not work on the engine until it cools.</p>
	

**Servicing the exhaust system. Hot parts can cause severe injury or death.** Do not touch hot engine parts. The engine and exhaust system components become extremely hot during operation.

**Required materials:**

- Fresh engine oil (See “Oil Recommendations.”)
- Collection container for drained oil-minimum 8 liter (2.1 gal.) capacity
- Replacement oil filter
- Oil filter wrench
- Clean, dry cloth
- Drop cloth to protect work surface

**Change the engine oil and oil filter:**

1. Stop the engine and allow it to cool.

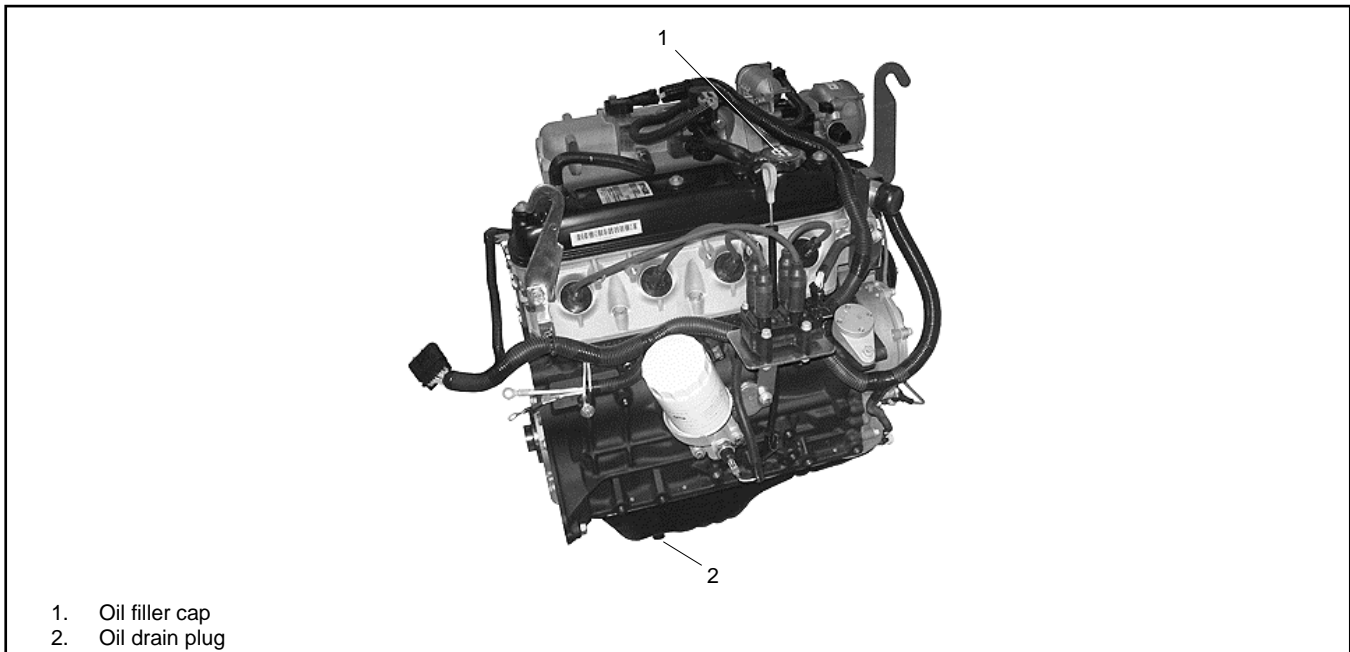

Figure 20 Oil Fill and Drain Plug Location

2. Place a drop cloth and collection container beneath the oil drain plug. See Figure 20.
3. Remove the oil drain plug and allow the oil to drain into the container.

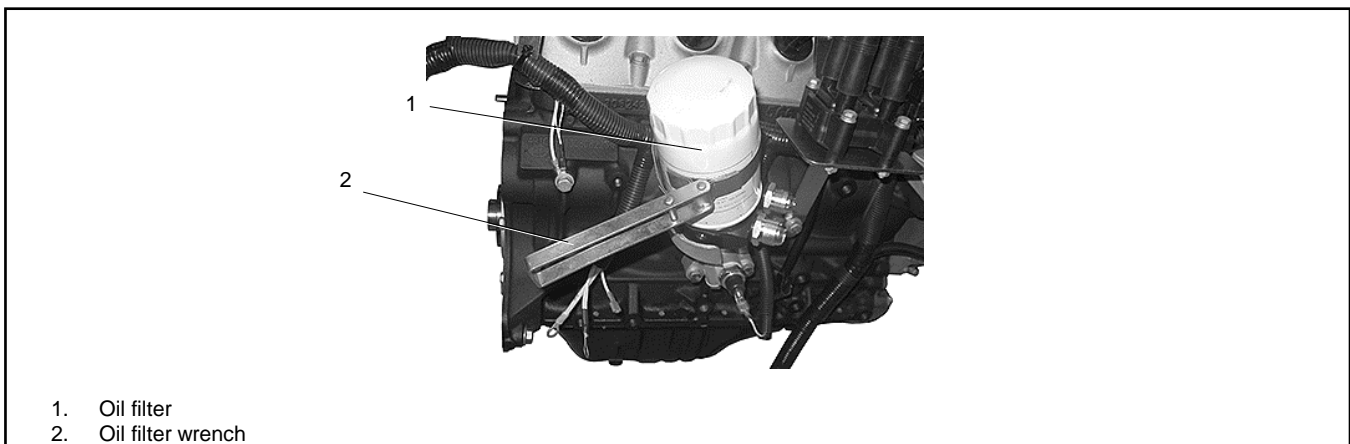

Figure 21 Oil Filter with wrench

4. Using an oil filter wrench, remove the old oil filter. See Figure 21.

**Note:**

After removing the oil filter, ensure that the oil cooler adapter nut is tightened to specification and that oil cooler adapter and gasket are seated properly.



### Oil Cooler Adapter Nut Torque, Nm (ft. lb.)

40 (29.5)

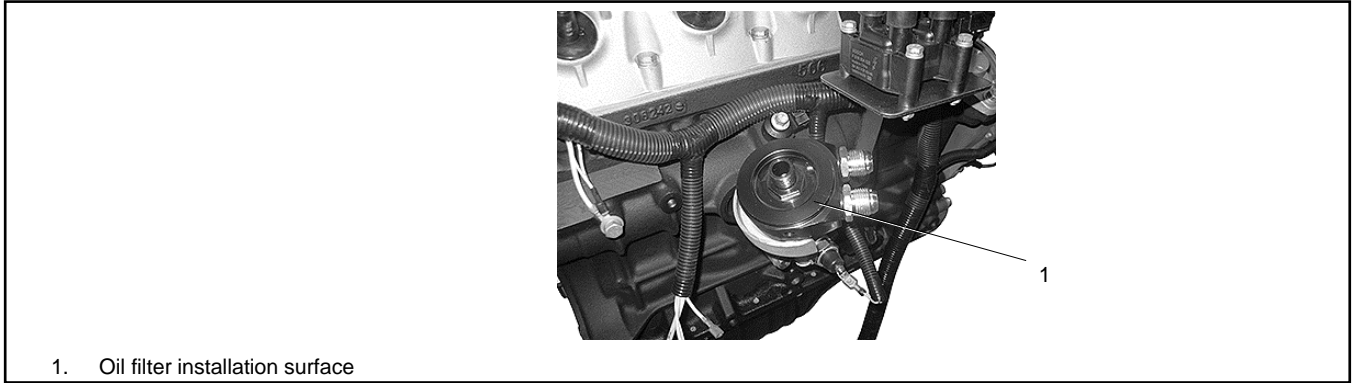

Figure 22 Oil Filter Installation Location

5. Wipe the oil filter installation surface clean with a dry cloth. Inspect the installation surface for damage. See Figure 22.
6. Apply a thin film of fresh oil to the gasket of the new oil filter.
7. Lightly screw in the new oil filter by hand until you feel resistance. Using the oil filter wrench, tighten the filter an additional 3/4 turn. See Figure 22.

### Filter Torque, Nm (ft. lb.)

25 (18.4)

8. Install the oil drain plug. Tighten to specification.

### Oil Pan Drain Plug Torque, Nm (ft. lb.)

20–25 (14.8–18.4)

9. Add fresh oil through the oil filler cap.

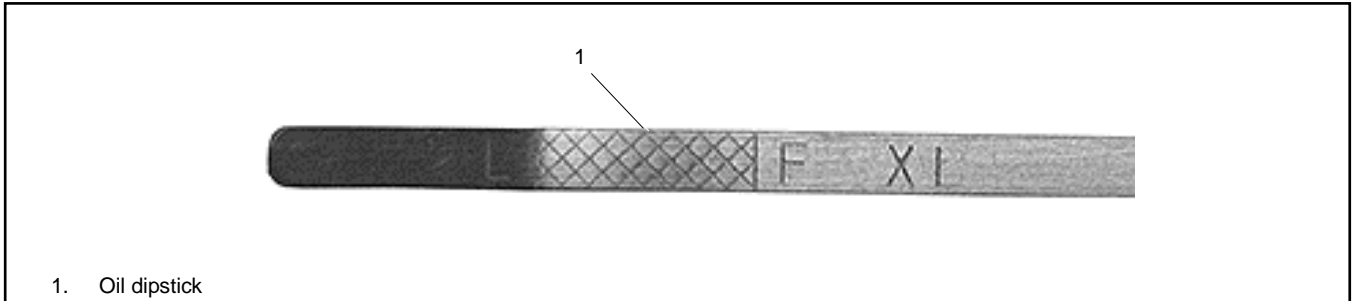

Figure 23 Oil Dipstick

10. Check engine oil level, making sure that the level lies between the L and F marks on the dipstick. See Figure 23.
11. Install and tighten the oil filler cap.
12. Start and run the engine without load for approximately 5 minutes. This will ensure that the fresh engine oil is distributed to each friction surface.

### Note:

Dispose of used engine oil and oil filters in accordance with local environmental regulations.

### 3.5.3 Check and Clean the Air Filter





Refer to the Operation Manual for the equipment using this engine.

### 3.5.4 Replace the Air Filter

Refer to the Operation Manual for the equipment using this engine.

### 3.5.5 Check, Adjust and Replace the Spark Plugs

Damaged, loose, or improperly adjusted spark plugs can overheat or cause engine problems such as misfiring, hesitation, or knocking. Check the spark plugs after each 500 hours of operation

 <b>CAUTION</b>	<b>Hazardous voltage. Electrical shock can cause injury.</b> Do not touch wires while the engine is running. Stop the engine and disconnect the battery leads, negative (-) lead first, before servicing the engine.
	
 <b>WARNING</b>	<b>Hot engine and exhaust system. Can cause severe injury or death.</b> Do not work on the engine until it cools.
	

**Servicing the exhaust system. Hot parts can cause severe injury or death.** Do not touch hot engine parts. The engine and exhaust system components become extremely hot during operation.

#### Required materials:

- Spark plug wrench
- Torque wrench
- Spark plug gap tool
- Clean, dry cloth
- Replacement spark plugs. See spark plug specifications in the Specifications section.

#### Procedure:

1. Stop the engine and allow it to cool.

#### Note:

Label or mark spark plug wires before disconnecting. Spark plug wires **MUST** be reconnected in the same order as removed.

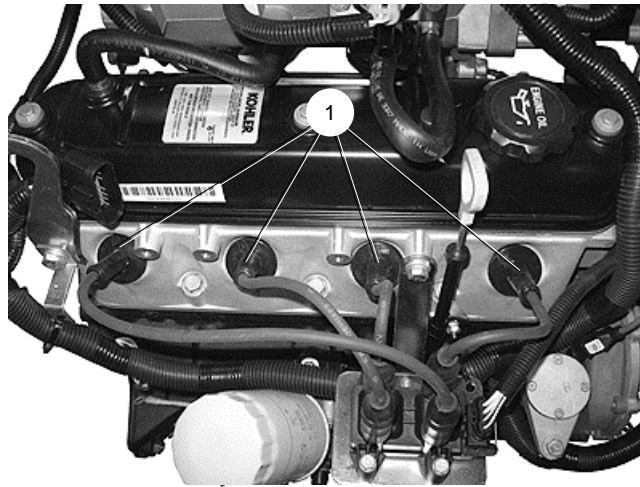

1. Spark plug wires

Figure 24 Spark Plug Wires

2. Use a cloth to wipe dirt and oil away from the area around each of the four spark plug wires. See Figure 24.
3. Disconnect the spark plug wires.
4. Wipe the interior of the spark plug tubes.
5. Use a spark plug wrench to remove the spark plugs.



1. Spark plug electrodes

Figure 25 Spark Plug Electrodes

6. Inspect the body of each spark plug for cracks, damage, or discoloration and check that the spark plug O-ring is in good condition.
7. Inspect the electrodes on each spark plug. See Figure 25. The electrodes should be light brown. If the electrode appears to be burned, covered with soot, or fouled with oil, replace the spark plug.

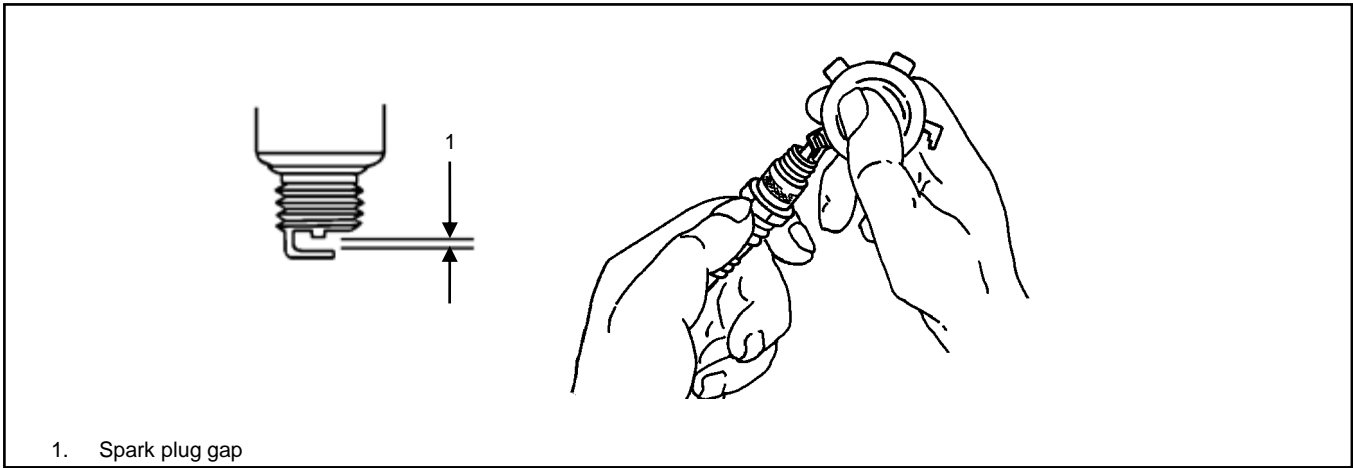

1. Spark plug gap

Figure 26 Spark Plug Gap

8. Use a spark plug gap tool to measure the gap on each spark plug. Adjust the gap to specification. See Figure 26.

Spark Plug Gap	
KG2204	0.9–1.0 mm (0.036–0.040 in.)
KG2204T	0.7–0.8 mm (0.028–0.031 in.)

**Note:**

Ensure that the spark plug tubes are seated before installing the spark plugs. If the tubes were removed, reinstall the tubes before installing the spark plugs.

9. Thread the spark plugs into the cylinder head.
10. Tighten the spark plugs to specification.

Spark Plug Torque	
KG2204	18 Nm (13.3 ft. lb.)
KG2204T	25 Nm (18.4 ft. lb.)



11. Reconnect the spark plug wires to the spark plugs.



### 3.5.6 Ignition Timing

The engine has an electronic ignition system. All functions of the ignition system, including timing, are controlled by the ECM and cannot be adjusted. Contact your Kohler authorized distributor/dealer for assistance with ignition-related performance issues.

## 3.6 Electrical System

### 3.6.1 Check Battery and Connections

 <b>WARNING</b>	<b>Sulfuric acid in batteries.</b> <b>Can cause severe injury or death.</b> Wear protective goggles and clothing. Battery acid may cause blindness and burn skin.
	

 <b>WARNING</b>	<b>Explosion.</b> <b>Can cause severe injury or death.</b> <b>Relays in the battery charger cause arcs or sparks.</b> Locate the battery in a well-ventilated area. Isolate the battery charger from explosive fumes.
	

**Battery electrolyte is a diluted sulfuric acid. Battery acid can cause severe injury or death.** Battery acid can cause blindness and burn skin. Always wear splashproof safety goggles, rubber gloves, and boots when servicing the battery. Do not open a sealed battery or mutilate the battery case. If battery acid splashes in the eyes or on the skin, immediately flush the affected area for 15 minutes with large quantities of clean water. Seek immediate medical aid in the case of eye contact. Never add acid to a battery after placing the battery in service, as this may result in hazardous spattering of battery acid.

**Battery acid cleanup. Battery acid can cause severe injury or death.** Battery acid is electrically conductive and corrosive. Add 500 g (1 lb.) of bicarbonate of soda (baking soda) to a container with 4 L (1 gal.) of water and mix the neutralizing solution. Pour the neutralizing solution on the spilled battery acid and continue to add the neutralizing solution to the spilled battery acid until all evidence of a chemical reaction (foaming) has ceased. Flush the resulting liquid with water and dry the area.

**Battery gases. Explosion can cause severe injury or death.** Battery gases can cause an explosion. Do not smoke or permit flames or sparks to occur near a battery at any time, particularly when it is charging. Do not dispose of a battery in a fire. To prevent burns and sparks that could cause an explosion, avoid touching the battery terminals with tools or other metal objects. Remove all jewelry before servicing the equipment. Discharge static electricity from your body before touching batteries by first touching a grounded metal surface away from the battery. To avoid sparks, do not disturb the battery charger connections while the battery is charging. Always turn the battery charger off before disconnecting the battery connections. Ventilate the compartments containing batteries to prevent accumulation of explosive gases.

**Battery short circuits. Explosion can cause severe injury or death.** Short circuits can cause bodily injury and/or equipment damage. Disconnect the battery before maintenance. Remove all jewelry before servicing the equipment. Use tools with insulated handles. Remove the negative (–) lead first when disconnecting the battery. Reconnect the negative (–) lead last when reconnecting the battery. Never connect the negative (–) battery cable to the positive (+) connection terminal of the starter solenoid. Do not test the battery condition by shorting the terminals together.



Check the condition of the battery and connections according to the intervals specified in “Periodic Maintenance Schedule.” Specific items to look for are:

- Loose or missing fasteners on the battery hold-down.
- Loose cable connections.
- Frayed, cut, or broken cables.
- Cracks in battery cell cover or case.
- Dirt, oil, or water contamination.
- Corrosion at battery terminals.
- Reduction in voltage or ability to hold a charge.



Repair or replace the battery and/or components as needed. Use only replacement parts that are equivalent to the original equipment. Contact your Kohler authorized distributor/dealer for assistance.

### 3.6.2 Check and Adjust the Drive Belt

A worn, stretched, or damaged drive belt may fail, especially under heavy loads. Check the condition of the drive belt regularly and adjust belt tension as needed.

 <b>WARNING</b>	<b>Accidental starting.</b> <b>Can cause severe injury or death.</b>
	Disconnect the battery cables before working on the engine. Remove the negative (-) lead first when disconnecting the battery. Reconnect the negative (-) lead last when reconnecting the battery.

**Disabling the engine. Accidental starting can cause severe injury or death.** Before working on the engine or connected equipment, disable the engine as follows: 1) Disconnect the ignition coil. 2) Remove the battery cables, negative (-) lead first. Reconnect the negative (-) lead last when reconnecting the battery. Follow these precautions to prevent the accidental starting of the engine.

 <b>WARNING</b>	<b>Moving parts.</b> <b>Can cause severe injury or death.</b>
	Operate the engine only when all guards and electrical enclosures are in place. Stay away from moving parts while the engine is in operation.

**Servicing the engine when it is operating. Exposed moving parts can cause severe injury or death.** Keep hands, feet, hair, clothing, and test leads away from the belts and pulleys when the engine is running. Replace guards, screens, and covers before operating the engine.

#### Required materials:

- Belt tension gauge or straightedge and steel rule.

#### Check drive belt condition:

1. Stop the engine and allow it to cool.

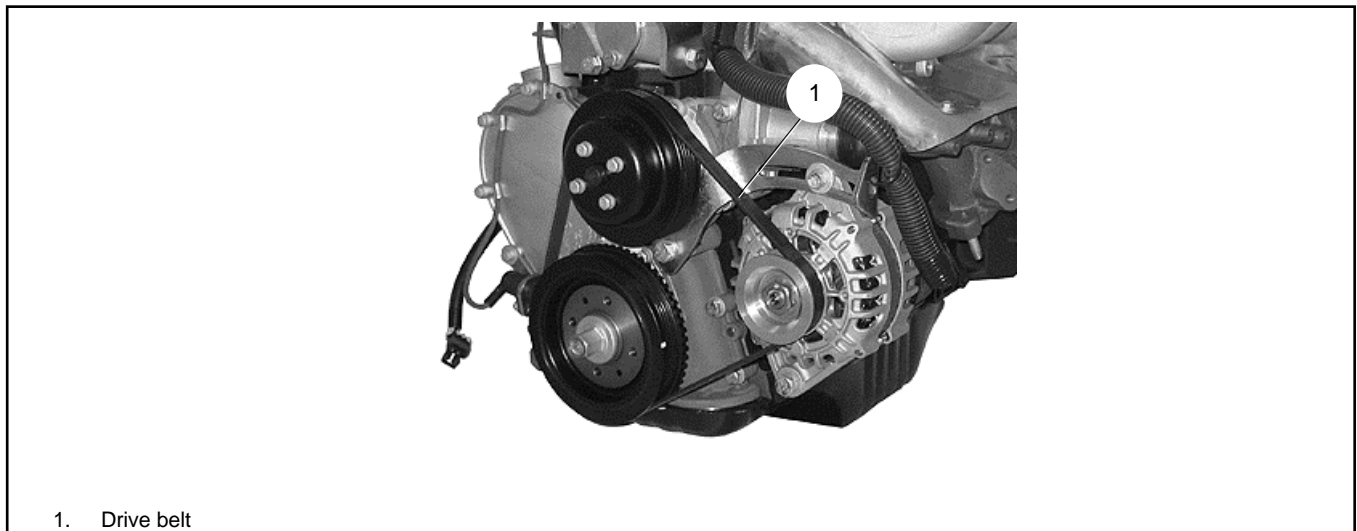

Figure 27 Drive Belt Location

2. Locate the drive belt. See Figure 27.

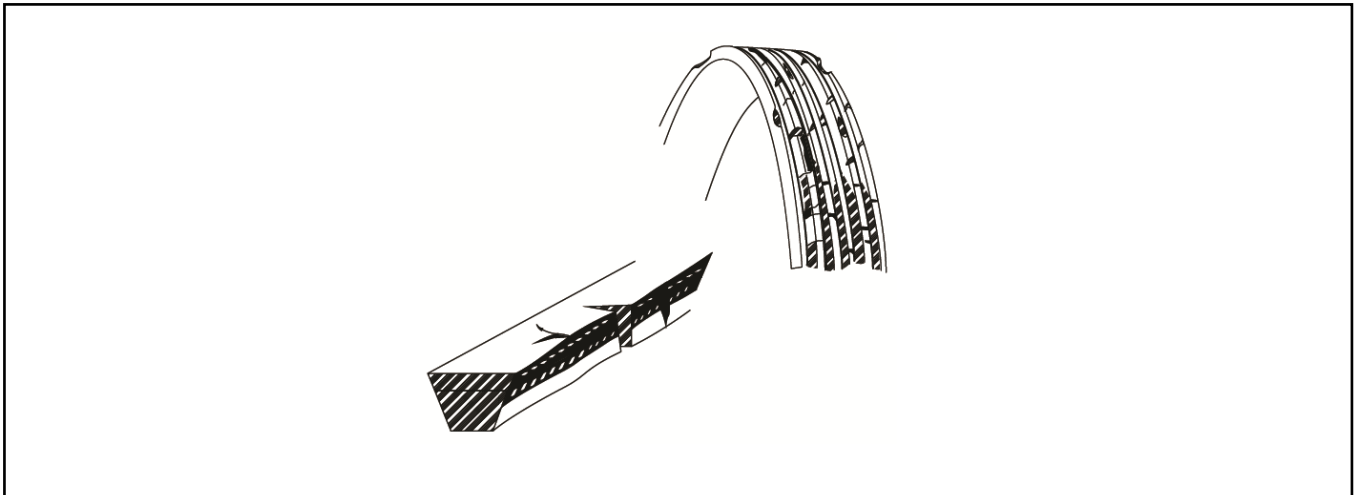
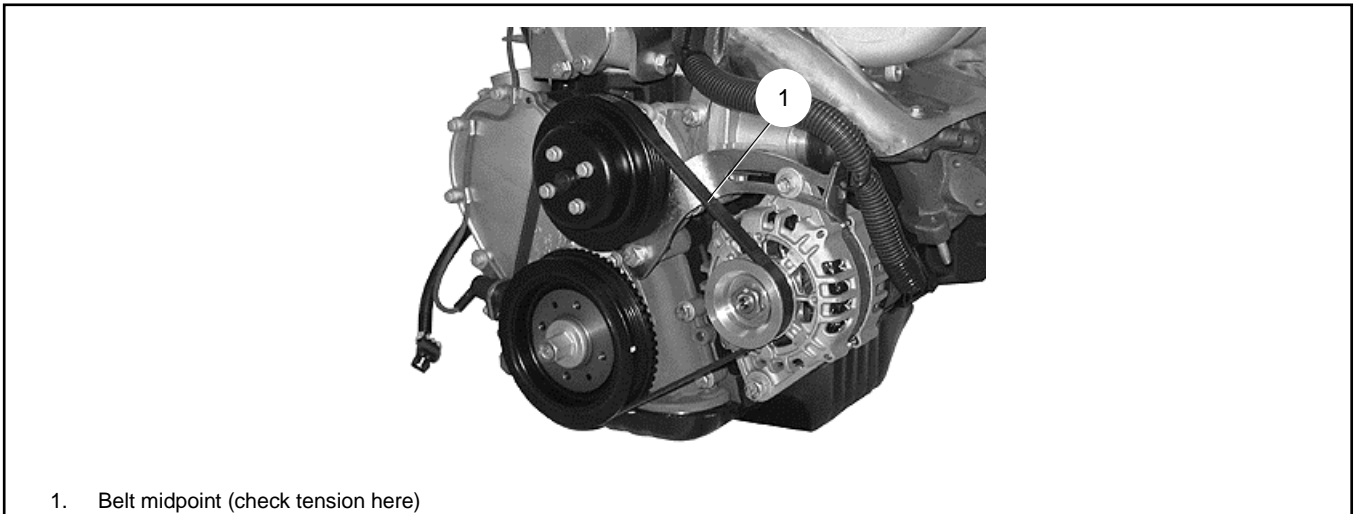

Figure 28 Drive Belt

3. Inspect the drive belt. Look for signs of cracking, separation, cuts, or other damage. See Figure 28.
4. If any abnormality is found, replace the drive belt.

**Check drive belt tension:**



1. Belt midpoint (check tension here)

Figure 29 Drive Belt Location

1. The drive belt tension should be checked at the midpoint between the pulleys. See Figure 29.
  - Apply specified pressure to the drive belt at its midpoint. At the same time, measure the amount of deflection of the drive belt at its midpoint. Deflection should be within specification.

**Drive Belt Tension**

- Applied Test Pressure, N (lb.)  
98 (22)
  - Belt Deflection – New, mm (in.)  
5–7 (0.20–0.28)
  - Belt Deflection - Used, mm (in.)  
7–8 (0.28–0.31)
2. If the amount of deflection is out of specification, adjust the drive belt tension.

**Adjust Drive Belt Tension:**

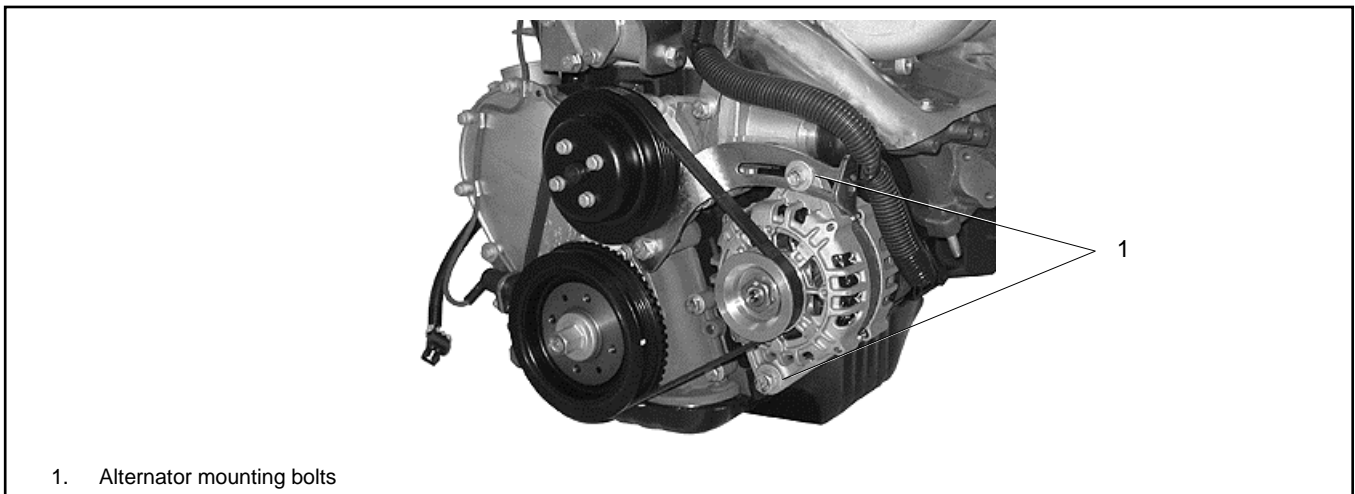

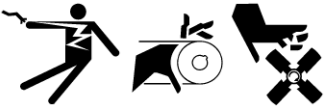



Figure 30 Alternator Mounting Bolts

1. Loosen the two alternator mounting bolts. See Figure 30.
2. To increase tension, move the alternator away from the engine. To decrease tension, move the alternator toward the engine.
3. Tighten two alternator mounting bolts.
4. Check the drive belt tension. Repeat the adjustment procedure if necessary until the drive belt tension is within specification.

**3.6.3 Replace the Drive Belt**

 <b>WARNING</b>	<p><b>Accidental starting.</b> <b>Can cause severe injury or death.</b></p> <p>Disconnect the battery cables before working on the engine. Remove the negative (-) lead first when disconnecting the battery. Reconnect the negative (-) lead last when reconnecting the battery.</p>
	

**Disabling the engine. Accidental starting can cause severe injury or death.** Before working on the engine or connected equipment, disable the engine as follows: 1) Disconnect the ignition coil. 2) Remove the battery cables, negative (-) lead first. Reconnect the negative (-) lead last when reconnecting the battery. Follow these precautions to prevent the accidental starting of the engine.

 <b>WARNING</b>	<p><b>Moving parts.</b> <b>Can cause severe injury or death.</b></p> <p>Operate the engine only when all guards and electrical enclosures are in place. Stay away from moving parts while the engine is in operation.</p>
	

**Servicing the engine when it is operating. Exposed moving parts can cause severe injury or death.** Keep hands, feet, hair, clothing, and test leads away from the belts and pulleys when the engine is running. Replace guards, screens, and covers before operating the engine.



**Required materials:**

- Replacement drive belt.
- Belt tension gauge or straightedge and steel rule.

**NOTICE**

Do not replace a drive belt with one that is old or worn. An old or worn replacement may not last as long as a new drive belt and may not hold consistent tension, especially under load.

**Procedure**

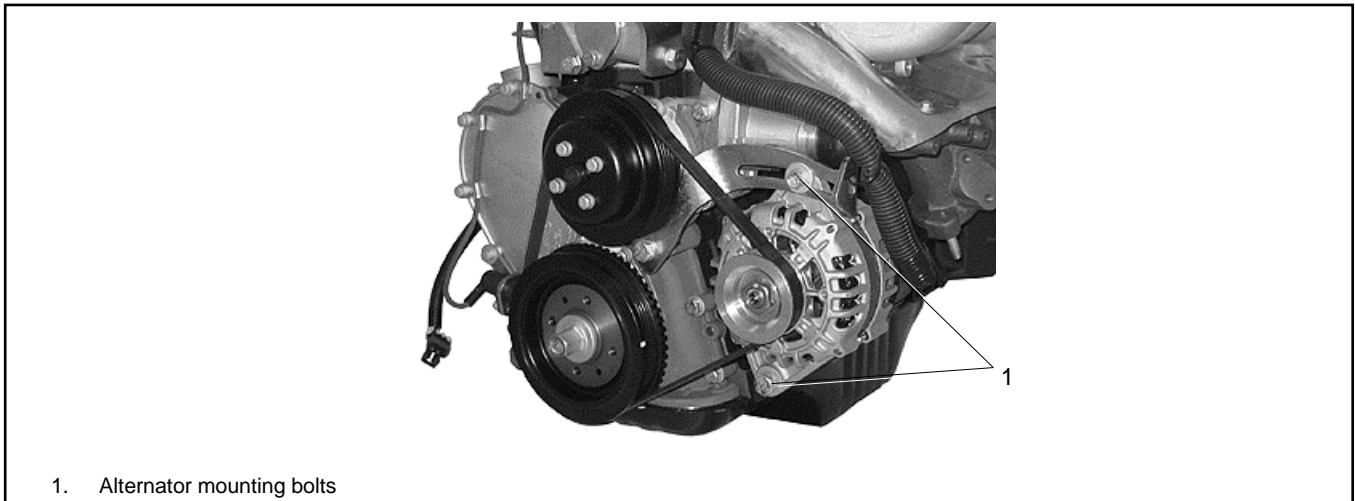

Figure 31 Alternator Mounting Bolts

1. Loosen the two alternator mounting bolts on the alternator and mounting bracket. See Figure 31.
2. Remove and discard the old drive belt.

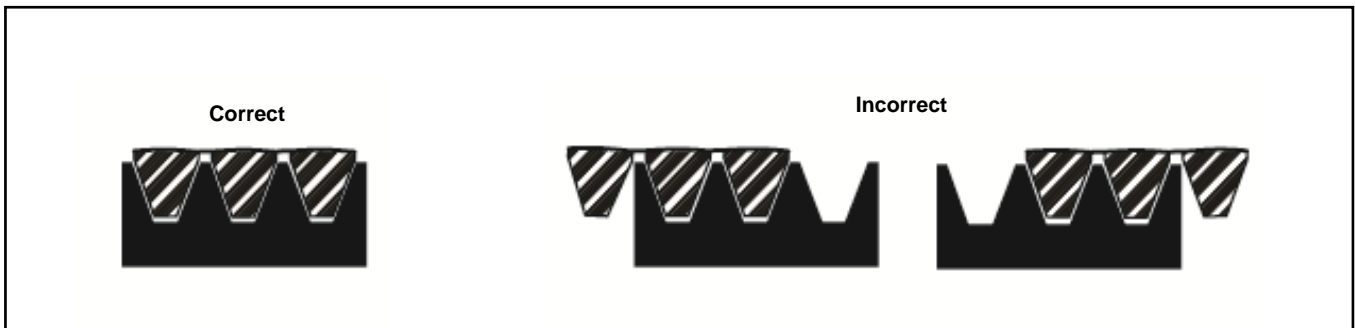
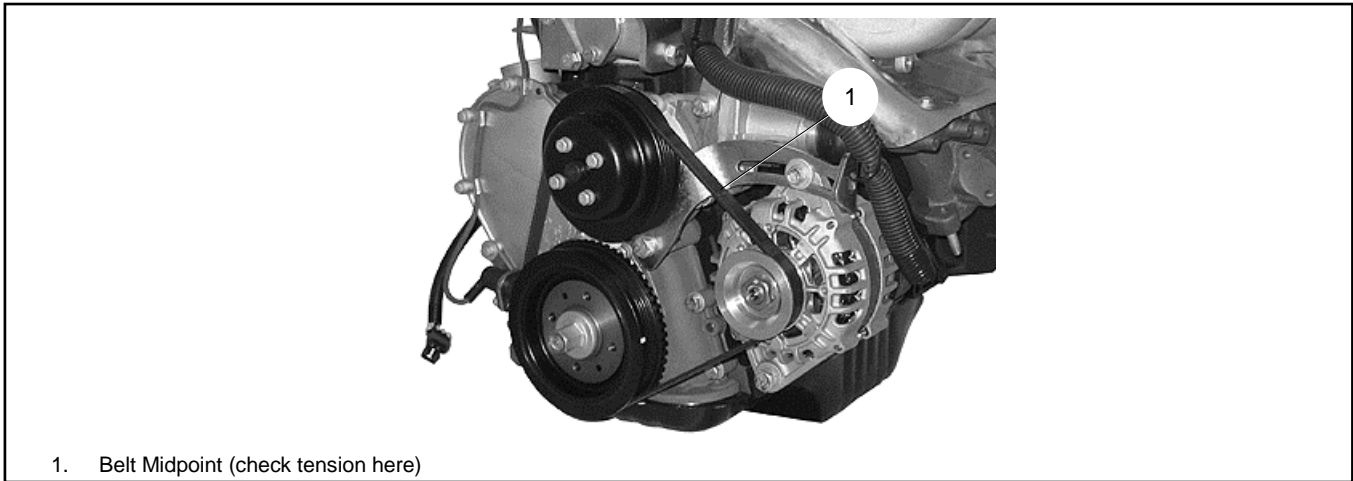

Figure 32 Drive Belt Alignment

3. Place the new drive belt on the pulleys. Make sure that the belt is properly aligned with the grooves on each pulley. See Figure 32.



1. Belt Midpoint (check tension here)



Figure 33 Drive Belt Location

4. Set drive belt tension to specification. See Figure 33.
  - Apply specified pressure to the drive belt at its midpoint. At the same time, measure the amount of deflection of the drive belt at its midpoint. Deflection should be within specification.

**Drive Belt Tension**

- Applied Test Pressure, N (lb.)  
98 (22)
  - Belt Deflection – New, mm (in.)  
5–7 (0.20–0.28)
  - Belt Deflection – Used, mm (in.)  
7–8 (0.28–0.31)
5. Tighten the two alternator mounting bolts.
  6. Check the drive belt tension and adjust the alternator position as needed until correct drive belt tension is reached.

**3.6.4 Check Wiring and Electrical Connections**



 <b>CAUTION</b>	<p><b>Hazardous voltage.</b> <b>Electrical shock can cause injury.</b></p> <p>Do not touch wires while the engine is running. Stop the engine and disconnect the battery leads, negative (-) lead first, before servicing the engine.</p>
	

Check the condition of the wiring and electrical connections after every 10 hours of operation. Specific items to look for are:

- Exposed (bare) wires.
- Cuts or abrasions in wire insulation.
- Loose connections at screw terminals.
- Loose, dirty, or cracked electrical connectors.
- Melted or scorched wiring, insulation, or connectors.

Repair or replace faulty electrical components before operating the machine.

### 3.7 Cooling system

 <b>WARNING</b>	<b>Hot coolant and steam. Can cause severe injury or death.</b> Before removing the pressure cap, stop the engine and allow it to cool. Then loosen the pressure cap to relieve pressure.
	

#### 3.7.1 Check Coolant Level and Condition

The engine coolant level should be checked daily before starting the engine. Insufficient coolant will cause the engine to overheat.

1. Open the radiator cap slowly in order to release the pressure in the system.
2. Maintain the coolant level in the coolant overflow bottle between the High and Low markings. See “Coolant Recommendations.”

**Note:**

Periodically check the coolant level by removing the radiator’s pressure cap. Do not rely solely on the level in the coolant overflow bottle.

3. Install and tighten the radiator cap.

**Check coolant condition:**

Engine coolant should be uniformly colored and transparent. Replace the coolant if it is dirty, discolored, or fouled with oil or rust particles.

Rusty coolant may indicate corrosion inside the radiator. Oil in the coolant indicates a leak somewhere in the lubrication system. Contact a Kohler authorized distributor/dealer if either of these conditions exist.

#### 3.7.2 Check Hoses and Clamps

Check the condition of the coolant system hoses and clamps every 10 hours of operation.

**Hoses:**

- Inspect the hoses for cracks, abrasions, cuts, bulges, swollen ends, or leaks.
- Squeeze the hoses. They should yield slightly to moderate pressure and not feel too hard, too soft, or spongy.
- Replace faulty hoses before operating the engine.



**Clamps:**

- Verify that all clamps are in place.
- Adjust and tighten clamps as needed.

#### 3.7.3 Draining and Replacing the Coolant

There are no coolant plugs or drainage valves on the engine. To drain and replace the coolant, refer to the radiator procedures in the Operation Manual for the equipment using this engine.

### 3.8 Fuel System

 <b>WARNING</b>	<b>Explosive fuel vapors. Can cause severe injury or death.</b> Use extreme care when handling, storing, and using fuels.
	

**The fuel system. Explosive fuel vapors can cause severe injury or death.** Vaporized fuels are highly explosive. Use extreme care when handling and storing fuels. Store fuels in a well-ventilated area away from spark-producing equipment and out of the reach of children. Never add fuel to the tank while the engine is running because spilled fuel may ignite on contact with hot parts or from sparks. Do not smoke or permit flames or sparks to occur near sources of spilled fuel or fuel vapors. Keep the fuel lines and connections tight and in good condition. Do not replace flexible fuel lines with rigid lines. Use flexible sections to avoid fuel line breakage caused by vibration. Do not operate the engine in the presence of fuel leaks, fuel accumulation, or sparks. Repair fuel systems before resuming engine operation.

**Gas fuel leaks. Explosive fuel vapors can cause severe injury or death.** Fuel leakage can cause an explosion. Check the LPG vapor or natural gas fuel system for leakage by using a soap and water solution with the fuel system test pressurized to 6–8 ounces per square inch (10–14 inches water column). Do not use a soap solution containing either ammonia or chlorine because both prevent bubble formation. A successful test depends on the ability of the solution to bubble.

**LPG liquid withdrawal fuel leaks. Explosive fuel vapors can cause severe injury or death.** Fuel leakage can cause an explosion. Check the LPG liquid withdrawal fuel system for leakage by using a soap and water solution with the fuel system test pressurized to at least 90 psi (621 kPa). Do not use a soap solution containing either ammonia or chlorine because both prevent bubble formation. A successful test depends on the ability of the solution to bubble.

**Note:**

Fuel system components are not adjustable and cannot be serviced. Contact your authorized KOHLER authorized distributor/dealer for replacements.

#### 3.8.1 Check Fuel Supply Pipe and Connections

With the fuel valve fully opened and the engine stopped, check all fuel system connections and lines for leaks using a soapy water solution. Correct any leaks before restarting the engine. **Do not start the engine if you can smell leaking gas.** Have any necessary service performed by a Kohler authorized distributor/dealer.

#### 3.8.2 Check Fuel Level (LPG only)

With the fuel valve on the LPG tank fully closed and the engine stopped, check the fuel gauge on the LPG tank. Make sure that the tank contains enough fuel for sustained operation. If not, refill the tank before restarting the engine.

Fully open the fuel valve on the LPG tank. Check all fuel supply connections and lines for leaks using a soapy water solution. Correct any leaks before restarting the engine. Have any necessary service performed by a Kohler authorized distributor/dealer or qualified LPG/NG technician only.

## Section 4. Troubleshooting

### 4.1 Introduction









The following chart will help you to identify and solve some of the basic operating problems that may occur while operating this engine.

Do not attempt to service or replace major engine components, or any items that require special timing or adjustment procedures. This work should be performed only by a Kohler authorized distributor/dealer.

### 4.2 Troubleshooting

Problem	Possible Cause	Solution
Will Not Start	No fuel	Check fuel supply.
	Incorrect fuel	Make sure fuel system is configured properly for LPG or NG supply.
	Dirty/restricted fuel system	Check fuel system and clean components as needed.
	Incorrect oil level	Check engine oil level; add as needed.
	Engine overloaded	Disconnect or reduce loads.
	Faulty spark plug	Inspect, adjust, or replace as needed.
Hard Starting	No fuel	Check fuel supply.
	Incorrect fuel	Make sure fuel system is configured properly for LPG or NG supply.
	Restricted fuel flow	Make sure fuel supply valves are open; check for air intake system leakage.
	Dirty/restricted fuel system	Check fuel system and clean components as needed.
	Incorrect oil level	Check engine oil level; add as needed.
	Engine overloaded	Disconnect or reduce loads.
Stops Suddenly	Faulty spark plug	Inspect, adjust, or replace as needed.
	No fuel	Check fuel supply.
	Dirty/restricted fuel system	Check fuel system and clean components as needed.
	Engine overloaded	Disconnect or reduce loads.
Lacks Power	Incorrect oil level	Check engine oil level; add as needed.
	Engine overloaded	Disconnect or reduce loads.
	Faulty spark plug	Inspect, adjust, or replace as needed.
	Dirty/restricted fuel system	Check fuel system and clean components as needed.
	Air induction system leak	Inspect air induction system.
	Damaged turbocharger	Inspect turbocharger compressor and turbine blades for damage and/or contact against housing.
	Low fuel pressure	Check and adjust fuel pressure.
Operates Erratically or Unevenly	Incorrect fuel	Make sure fuel system is configured properly for LPG or NG supply.
	Dirty/restricted fuel system	Check fuel system and clean components as needed.
	Low fuel supply pressure	Check and adjust.
	Engine overloaded	Disconnect or reduce loads.
	Loose wiring at shut-off valve(s)	Check wiring and repair connections.

<b>Problem</b>	<b>Possible Cause</b>	<b>Solution</b>
	Faulty spark plug	Inspect, adjust, or replace as needed.
	Dirty air filter	Inspect and replace as needed.
Knocks or Pings	Incorrect fuel	Make sure fuel system is configured properly for LPG or NG supply.
	Engine overloaded	Disconnect or reduce loads.
	Faulty spark plug	Inspect, adjust, or replace as needed.
	Dirty/restricted fuel system	Check fuel system and clean components as needed.
	Dirty air filter	Inspect and replace as needed.
	Boost pressure too high	Check for stuck wastegate, check for leak in wastegate boost line.
	Excessive intake manifold temperature	Check charge air cooler for debris and clean as needed.
Skips or Misfires	Incorrect fuel	Make sure fuel system is configured properly for LPG or NG supply.
	Faulty spark plug	Inspect, adjust, or replace as needed.
	Dirty/restricted fuel system	Check fuel system and clean components as needed.
	Dirty air filter	Inspect and replace as needed.
Backfires	Incorrect fuel	Make sure fuel system is configured properly for LPG or NG supply.
	Faulty spark plug	Inspect, adjust, or replace as needed.
	Dirty/restricted fuel system	Check fuel system and clean components as needed.
	Dirty air filter	Inspect and replace as needed.
Overheats	Incorrect fuel	Make sure fuel system is configured properly for LPG or NG supply.
	Dirty/restricted fuel system	Check fuel system and clean components as needed.
	Incorrect oil level	Check engine oil level; add as needed.
	Engine overloaded	Disconnect or reduce loads.
	Faulty spark plug	Inspect, adjust, or replace as needed.
Consumes Excess Fuel	Faulty spark plug	Inspect, adjust, or replace as needed.
	Dirty/restricted air cleaner element	Clean or replace.
	Incorrect fuel pressure	Check and adjust fuel pressure.
ECM Does Not Store DTC	Faulty electrical connections, components, or wiring	Contact KOHLER service.
Erratic operation	Air induction system leak	Inspect air induction system.

 <b>WARNING</b>	<b>Hot engine and exhaust system.</b> <b>Can cause severe injury or death.</b>
	Do not work on the engine until it cools.
 <b>WARNING</b>	<b>Moving parts.</b> <b>Can cause severe injury or death.</b>
	Operate the engine only when all guards and electrical enclosures are in place. Stay away from moving parts while the engine is in operation.
 <b>CAUTION</b>	<b>Hazardous voltage.</b> <b>Electrical shock can cause injury.</b>
	Do not touch wires while the engine is running. Stop the engine and disconnect the battery leads, negative (-) lead first, before servicing the engine.
 <b>WARNING</b>	<b>Handling caustic engine fluids and chemical products.</b> <b>Can cause severe chemical burns, nausea, fainting, or death.</b>
	Most chemicals such as used engine oil, antifreeze/coolant, rustproofing agent, inhibiting oil, degreasing agent, spray paint, and adhesives are hazardous to health. Read and follow the user information found on the packaging. Avoid inhalation and skin contact. Use only in well-ventilated areas and use a protective mask when spraying. Store engine fluids and chemical products in a locked cabinet. Contact your local recycling center for disposal information and locations.

### 5.1 Preparation

If you plan to take the engine out of service for an extended period of time, prepare the engine according to the procedures described in this section. These preventive measures will help to protect your engine from the cumulative effects of rust and deterioration while it is not being used.

- Perform scheduled periodic maintenance tasks.
- Make all necessary repairs and adjustments.
- Close the fuel valves and disconnect the fuel supply.
- Clean the outside of the engine. Wipe away all visible dirt, dust, and oil.
- Remove the starting key.

### 5.2 Short-Term Storage (Less than 30 Days)

- Disconnect and remove the battery.
- Cover or cap all intake and exhaust ports, including fuel lines, air filter, and engine exhaust.
- Cover the engine with a clean, dry cloth.
- Store the engine in a secure, dry location away from trespassers, children, and animals.

### 5.3 Long-Term Storage (More than 30 Days)

In addition to the short-term tasks, perform the following tasks before placing the engine in storage:

- Change the engine oil and filter.
- Loosen the drive belt.
- Protect the cylinders from rust:
  - Disconnect the spark plug wires and remove the spark plugs.
  - Squirt approximately 30 ml (1 ounce) of fresh engine oil into each cylinder.
  - Manually rotate the crankshaft 10–15 times to distribute the oil evenly in the cylinders.
  - Install the spark plugs and reconnect the spark plug wires.
- Cover all exposed metal parts with a suitable protectant.
- Coat all electrical connectors with a suitable protectant.

### 5.4 Maintenance while in Storage

- Inspect the engine regularly (at least once a month). Check for signs of rust or leaks.
- Periodically test the battery voltage and recharge as needed. The battery may lose charge even when disconnected.

### 5.5 Removal from Storage

- Remove protective cloths, covers, and caps from the engine.
- Clean protectant from exposed metal parts and electrical components.
- Tighten the alternator belt.
- Check fluid levels and fill as needed.
- Connect the battery.
- Connect the fuel supply and open fuel valves.
- Start the engine and allow it to run for several minutes without load. Check for leaks and watch for signs of abnormal operation.

**NOTE:**

The engine may smoke when started for the first time after being taken out of storage. This is normal and occurs as the engine burns away the protective oil coating inside the cylinders.

- Check oil pressure and fuel pressure gauges to make sure that the engine is operating normally.



## Section 6. Specifications

### 6.1 Engine Specifications

Item	Specifications	
	KG2204	KG2204T
Engine Model	KG2204	KG2204T
Block Type	I-4	
Number of Cylinders	4	
Cylinder Bore, mm (in.)	91 (3.5)	
Piston Stroke, mm (in.)	86 (3.4)	
Displacement, L (in. <sup>3</sup> )	2.2 (134.25)	
Rated Output kW (HP) @ 1800 rpm	30 (40)	47.8 (64.1)
Fuel Type	Propane, Liquid Petroleum Gas (LPG) or Natural Gas (NG). See "Fuel Specifications."	
Oil Type / Weight	KOHLER synthetic engine oil, SAE Class SJ or higher. Variable per ambient temperature. See "Oil Recommendations."	
Oil Dry Fill Capacity, L (qt.)	4.2 (4.4)	
Rotating Direction of Crankshaft	Counterclockwise (face to flywheel)	
Compression Ratio	10.5:1	
Cylinder Fire Order	1-3-4-2	
Lubricating Style	Pressurized	
Starting Style	Electric	
Net Weight (Dry), kg (lb.)	145 (320)	
Overall Dimensions (L x W x H), mm (in.)	826 x 547 x 647 (32.5 x 21.5 x 25.5)	
Aspiration	Natural	Turbocharged
Charge Air Cooler	NA	Aluminum core

### 6.2 Main Components Specifications

Item	Specifications	
	KG2204	KG2204T
Oil Filter/ Breather	Paper, Rocker Arm Covers, Top Oil Filter	
Oil Pump	Rotor type	
Water Pump	Centrifugal type; no fan	
Flywheel	Flywheel with attachment provisions for flywheel adapter (KOHLER part number GM88832)	
Thermostat Settings Valve open at °C (°F) Valve lift fully open at °C (°F)	76 (169) 88 (190)	
Alternator	Rated voltage 14 V, rated current 90 A	
Electric Starter	1.2 kW, speed reduction type	
Ignition System	Electronic.	
Spark Plug	GM92785 (KG2204 only) Screw thread M14 x 1.25	GM100158 (use only genuine Kohler service parts)

### 6.3 Adjustment Specifications

Item	Specifications	
	KG2204	KG2204T
Spark Plug Gap, mm (in.)	0.9–1.0 (0.036–0.040)	0.7–0.8 (0.028–0.030)
Drive Belt Tension at pressure of 98 N (22 lb), Deflection of a new belt, mm (in.) Deflection of a used belt, mm (in.)	5–7 (0.20–0.28) 7–8 (0.28–0.31)	
Fuel Pressure Regulator	Nonadjustable, LPG or NG selectable	
Throttle	Nonadjustable, ECM controlled	
Air–Fuel Mixer	Tamper-proof; nonadjustable	
Fuel Control Valve	Nonadjustable	

### 6.4 Torque Specifications

Item	Torque
Spark Plugs - KG2204, Nm (ft. lb.)	18 (13.3)
Spark Plugs - KG2204T, Nm (ft. lb.)	25 (18.4)
Oil Drain Plug, Nm (ft. lb.)	20–25 (14.8–18.4)

## 6.5 Standard Torque Specifications

American Standard Fasteners Torque Specifications					
Size	Torque Measurement	Assembled into Cast Iron or Steel			Assembled into Aluminum Grade 2 or 5
		Grade 2	Grade 5	Grade 8	
8-32	Nm (in. lb.)	1.8 (16)	2.3 (20)	-	See Note 3
10-24	Nm (in. lb.)	2.9 (26)	3.6 (32)	-	
10-32	Nm (in. lb.)	2.9 (26)	3.6 (32)	-	
1/4-20	Nm (in. lb.)	6.8 (60)	10.8 (96)	14.9 (132)	
1/4-28	Nm (in. lb.)	8.1 (72)	12.2 (108)	16.3 (144)	
5/16-18	Nm (in. lb.)	13.6 (120)	21.7 (192)	29.8 (264)	
5/16-24	Nm (in. lb.)	14.9 (132)	23.1 (204)	32.5 (288)	
3/8-16	Nm (ft. lb.)	24.0 (18)	38.0 (28)	53.0 (39)	
3/8-24	Nm (ft. lb.)	27.0 (20)	42.0 (31)	60.0 (44)	
7/16-14	Nm (ft. lb.)	39.0 (29)	60.0 (44)	85.0 (63)	
7/16-20	Nm (ft. lb.)	43.0 (32)	68.0 (50)	95.0 (70)	
1/2-13	Nm (ft. lb.)	60.0 (44)	92.0 (68)	130.0 (96)	
1/2-20	Nm (ft. lb.)	66.0 (49)	103.0 (76)	146.0 (108)	
9/16-12	Nm (ft. lb.)	81.0 (60)	133.0 (98)	187.0 (138)	
9/16-18	Nm (ft. lb.)	91.0 (67)	148.0 (109)	209.0 (154)	
5/8-11	Nm (ft. lb.)	113.0 (83)	183.0 (135)	259.0 (191)	
5/8-18	Nm (ft. lb.)	128.0 (94)	208.0 (153)	293.0 (216)	
3/4-10	Nm (ft. lb.)	199.0 (147)	325.0 (240)	458.0 (338)	
3/4-16	Nm (ft. lb.)	222.0 (164)	363.0 (268)	513.0 (378)	
1-8	Nm (ft. lb.)	259.0 (191)	721.0 (532)	1109.0 (818)	
1-12	Nm (ft. lb.)	283.0 (209)	789.0 (582)	1214.0 (895)	
Metric Fasteners Torque Specifications					
Size	Torque Measurement	Assembled into Cast Iron or Steel			Assembled into Aluminum Grade 5.8 or 8.8
		Grade 5.8	Grade 8.8	Grade 10.9	
M6 x 1.00	Nm (ft. lb.)	6.2 (4.6)	12 (9)	13.6 (10)	See Note 3
M8 x 1.25	Nm (ft. lb.)	15.0 (11)	29.6 (22)	33.0 (24)	
M8 x 1.00	Nm (ft. lb.)	16.0 (11)	24.0 (18)	34.0 (25)	
M10 x 1.50	Nm (ft. lb.)	30.0 (22)	52.5 (39)	65.0 (48)	
M10 x 1.25	Nm (ft. lb.)	31.0 (23)	47.0 (35)	68.0 (50)	
M12 x 1.75	Nm (ft. lb.)	53.0 (39)	80.0 (59)	115.0 (85)	
M12 x 1.50	Nm (ft. lb.)	56.0 (41)	85.0 (63)	122.0 (90)	
M14 x 2.00	Nm (ft. lb.)	83.0 (61)	135.0 (100)	180.0 (133)	
M14 x 1.50	Nm (ft. lb.)	87.0 (64)	133.0 (98)	190.0 (140)	
M16 x 2.00	Nm (ft. lb.)	127.0 (94)	194.0 (143)	278.0 (205)	
M16 x 1.50	Nm (ft. lb.)	132.0 (97)	201.0 (148)	287.0 (212)	
M18 x 2.50	Nm (ft. lb.)	179.0 (132)	273.0 (201)	390.0 (288)	
M18 x 1.50	Nm (ft. lb.)	189.0 (140)	289.0 (213)	413.0 (305)	

**Note:**

1. The torque values above are general guidelines. Always use the torque values specified in the service manuals and/or assembly drawings when they differ from above torque values.
2. The torque values above are based on new plated threads. Increase torque values by 15% if non-plated threads are used.
3. Hardware threaded into aluminum must have either two diameters of thread engagement or a 30% or more reduction in the torque to prevent stripped threads.
4. Torque values are calculated as equivalent stress loading on American hardware with an approximate preload of 90% of the yield strength and a friction coefficient of 0.125.









**TP-6901 9/19c**

© 2014, 2016, 2018, 2019 by Kohler Co. All rights reserved.

**KOHLER®**

KOHLER CO. Kohler, Wisconsin 53044  
Phone 920-457-4441, Fax 920-459-1646  
For the nearest sales/service outlet in the  
US and Canada, phone 1-800-544-2444  
[KOHLERPower.com](http://KOHLERPower.com)