

FIRMAN[®]

OPERATOR'S MANUAL PORTABLE INVERTER GENERATOR

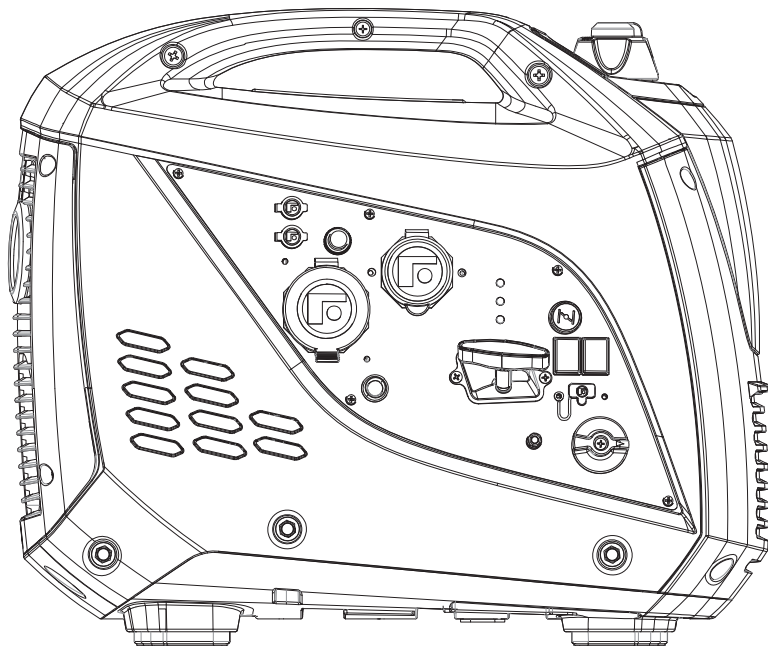

MODEL NUMBER
W01785
Rev Level:00

Record product information to reference when ordering parts or obtaining warranty coverage.

STOP DO NOT RETURN TO STORE!

CALL US FIRST
1-844-347-6261

FOR QUESTIONS OR SERVICE INFORMATION



SERIAL NUMBER: _____

PURCHASE DATE: _____

Supplier's Declaration of Conformity
47 CFR § 2.1077 Compliance Information

FIRMAN W01785 INVERTER GENERATOR

Firman Power Equipment
8716 W. Ludlow Dr. Suite #6
Peoria, AZ 85381

Telephone: 1-844-347-6261

www.firmanpowerequipment.com

FCC/IC Compliance Statement

1. This device complies with Part 15 of the FCC Rules. Operation is subject to the following two conditions:

1a. This device may not cause harmful interference.

1b. This device must accept any interference received, including interference that may cause undesired operation.

2. Changes or modifications not expressly approved by the party responsible for compliance could void the user's authority to operate the equipment.

NOTE: The FIRMAN W01785 inverter generator has been tested and found to comply with the limits for a Class B digital device, pursuant to part 15 of the FCC Rules. These limits are designed to provide reasonable protection against harmful interference in a residential installation. This equipment generates, uses and can radiate radio frequency energy and, if not installed and used in accordance with the instructions, may cause harmful interference to radio communications. However, there is no guarantee that interference will not occur in a particular installation. If this equipment does cause harmful interference to radio or television reception, which can be determined by turning the equipment off and on, the user is encouraged to try to correct the interference by one or more of the following measures:

- Reorient or relocate the receiving antenna.
- Increase the separation between the equipment and receiver.
- Connect the equipment into an outlet on a circuit different from that to which the receiver is connected.
- Consult the dealer or an experienced radio/TV technician for help.

Changes or modifications to equipment not expressly approved by FIRMAN could void the user's authority to operate the equipment.

INTRODUCTION

Table of Contents

Introduction	01
Features and Controls	05
Operation	11
Maintenance - Storage	22
Troubleshooting- Specifications	28
Parts Diagrams - Parts Lists - Wiring Diagram	30
Service - Warranty	35



INTRODUCTION

Thank you for purchasing a FIRMAN generator. You have selected a high-quality, precision engineered generator set designed and tested to give you years of satisfactory service. This generator is designed to run only on unleaded gasoline. This generator is not intended to be run unattended or to supply power to life safety support.

This manual contains safety information to make you aware of the hazards and risks associated with generator products and how to avoid them. This generator is designed and intended only for supplying electrical power for operating compatible electrical lighting, appliances, tools and motor loads, and is not intended for any other purpose. It is important that you read and understand these instructions thoroughly before attempting to start or operate this inverter generator. Save these original instructions for future reference.

All information in this publication is based on the latest production information available at the time of approval for printing. The manufacturer reserves the right to change, alter or otherwise improve the generator and this documentation at any time without prior notice.

SIGNAL WORDS

 DANGER	 WARNING	 CAUTION	NOTICE
Indicates a hazard which, if not avoided, will result in death or serious injury.	Indicates a hazard which, if not avoided, could result in death or serious injury.	Indicates a hazard which, if not avoided, could result in minor or moderate injury.	Indicates information considered Important, but not hazard-related.



Safety Alert Symbol- Indicates a potential personal injury hazard.



Operator's Manual- Failure to follow warnings, instructions and operator's manual could result in death or serious injury.



Toxic Fumes- Engine exhaust contains carbon monoxide, a poisonous gas that will kill you in minutes. You cannot smell it or see it.



Generator could cause electrical shock resulting in death or serious injury.



Fire- Fuel and its vapors are extremely flammable which could cause burns or fire resulting in death or serious injury. Engine exhaust could cause fire resulting in death or serious injury.



Hot Surface- Muffler could cause burns resulting in serious injury.

INTRODUCTION



WARNING! This product can expose you to chemicals including gasoline engine exhaust, which is known to the State of California to cause cancer, and carbon monoxide, which is known to the State of California to cause birth defects or other reproductive harm. For more information go to www.P65Warnings.ca.gov.

This outdoor generator can be used to power outdoor items using extension cords .

NOTICE If you have questions about intended use, contact FIRMAN customer service. This inverter generator is designed to be used only with FIRMAN authorized parts.

System Ground

The generator neutral is floating, which means that the AC stator winding is isolated from the grounding fastener and the AC receptacle ground pins. On a floating neutral generator the AC receptacle ground pins are not functional. Electrical devices, such as a ground fault circuit interrupter (GFCI), requiring a functioning AC receptacle ground pin will not operate.

Compliance Requirements

There may be Federal or State regulations, local codes, or ordinances that apply to the intended use of the generator. Consult a qualified electrician, electrical inspector, or the local agency having jurisdiction. This generator is not intended to be used at a construction site or similar activity as defined by NFPA 70-2020 (NEC) section 590.6.

To Restore Power Using Extension Cords

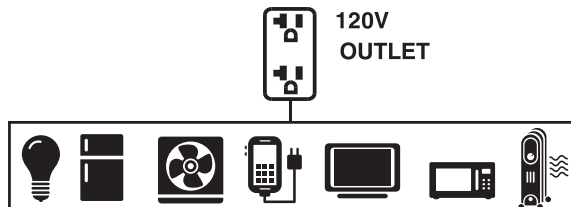

1. Only use grounded cords marked for outdoor use rated for your loads.

 To provide power using extension cords	
Total Amperage	Minimum Gauge, Outdoor Rated
	Up to 50 FT (15m)
Up to 13A	16
Up to 15A	14
Up to 20A	12
Up to 30A	10

2. Follow cord safety instructions.

3. Install carbon monoxide alarm(s).

4. When operating portable generator with extension cords, make sure portable generator is located in an open, outdoor area, at least 20 ft. (6 m) from occupied spaces with exhaust pointed away.

5. Extension cords running directly into your home, powering indoor items IS NOT RECOMMENDED.



DANGER! Engine exhaust contains carbon monoxide, a poisonous gas that will kill you in minutes. You cannot smell it, see it, or taste it. Even if you do not smell exhaust fumes, you could still be exposed to carbon monoxide gas.

- Extension cords running directly into the home increase your risk of carbon monoxide poisoning through any openings.
- If an extension cord running directly into your home is used to power indoor items, the operator recognizes that this increases the risk of CO poisoning to people inside the home and assumes that risk.

FEATURES AND CONTROLS

CONTROLS AND FEATURES

Generator

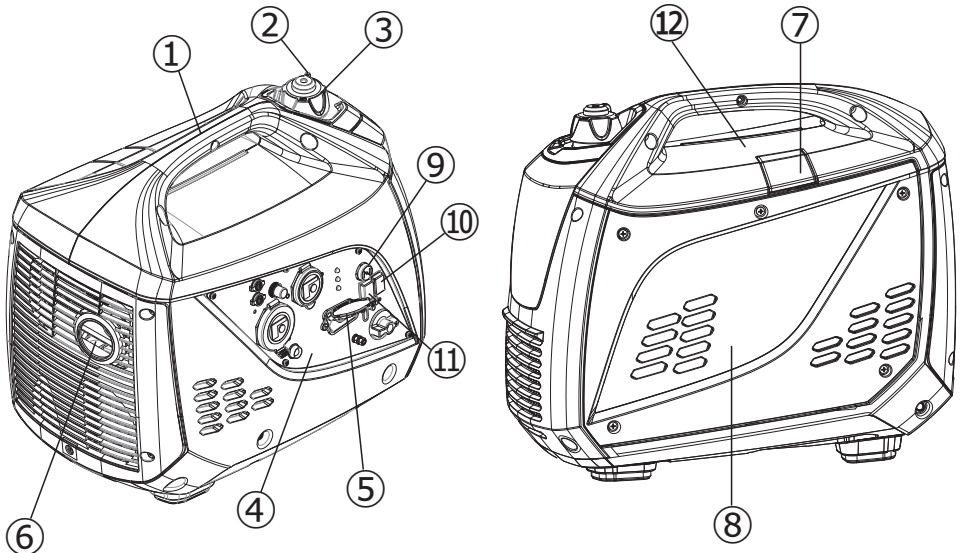

1- Carrying Handle

2- Fuel Lever Vent – Turn this valve to the “On” position to supply air to the tank.

3- Fuel Cap

4- Control Panel

5- Recoil Starter

6- Muffler/Spark Arrester

7- Spark Plug Access Cover

8- Maintenance Cover – Oil filler and air filter access.

9- Choke Knob

10- Engine ON/OFF Switch

11- Economy Control Switch

12- Data Decal/Serial Number



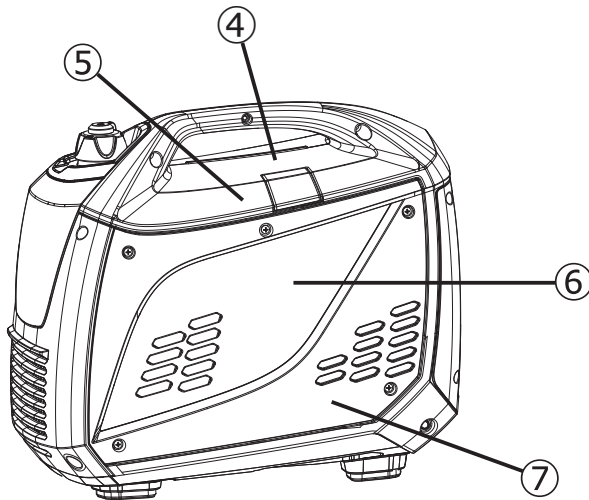
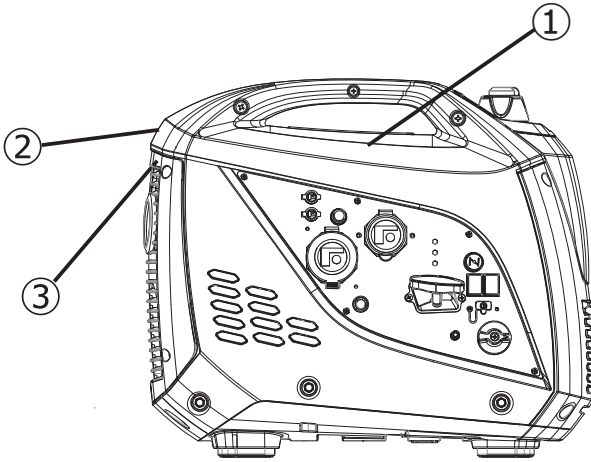

***We are always working to improve our products. Therefore, the enclosed product may differ slightly from the image on this page.**

FEATURES AND CONTROLS



FEATURES AND CONTROLS

①

 AUTOMATIC SHUTOFF - YOU MUST:	 CORTE AUTOMÁTICO-DEBE REALIZAR LO SIGUIENTE:	 ARRÊT AUTOMATIQUE - VOUS DEVEZ:
 <p>20 FT. (PIES) (6 m) MIN.</p>	<p>MOVE GENERATOR TO AN OPEN OUTDOOR AREA. POINT EXHAUST AWAY FROM HOMES. DON'T RUN GENERATOR IN ENCLOSED AREAS (e.g. NOT IN HOUSE OR GARAGE). AIR OUT PREMISES (OPEN WINDOWS AND DOORS) BEFORE REOCCUPYING PROPERTY.</p>	<p>MUEVA EL GENERADOR A UN ÁREA ABIERTA AL AIRE LIBRE, APUNTE EL ESCAPE LEJOS DE LAS CASAS, NO UTILICE EL GENERADOR EN ÁREAS CERRADAS (EN CASA O EL GARAJE). VENTILE LAS INSTALACIONES (VENTANAS Y PUERTAS ABIERTAS) ANTES DE VOLVER A OCUPAR LA PROPIEDAD.</p>
	<p>MOVE TO FRESH AIR AND GET MEDICAL HELP IF SICK, DIZZY OR WEAK.</p>	<p>DÉPLACEZ LA GÉNÉRATRICE DANS UN ESPACE EXTÉRIEUR OUVERT, ÉLOIGNEZ L'ÉCHAPPEMENT DES MAISONS, NE FAITES PAS FONCTIONNER LA GÉNÉRATRICE DANS DES ZONES FERMÉES (P. EX. PAS DANS LA MAISON NI DANS LE GARAGE). AÉREZ LES LIEUX (FENÊTRES ET PORTES OUVERTES) AVANT DE RÉINTÉGRER LA PROPRIÉTÉ.</p>

②

	<p>! WARNING: Muffler could cause burns resulting in serious injury.</p>	<p>! ADVERTENCIA: El silenciador podría causar quemaduras resultando en una lesión grave.</p>	<p>! AVERTISSEMENT: Le silencieux peut causer des brûlures et des blessures graves.</p>
--	---	--	--

③

Point engine exhaust away from all occupied structures.









Mantenga los gases de escape del motor lejos de instalaciones ocupadas.



Pointer l'échappement du moteur loin de toutes les structures occupées.

④

 DANGER	 PELIGRO	 DANGER
<p>Using a generator indoors CAN KILL YOU IN MINUTES. Generator exhaust contains carbon monoxide. This is a poison you cannot see or smell.</p>	<p>Utilizar un generador en interiores PUEDE PROVOCARLA MUERTE EN CUESTIÓN DE MINUTOS. Los gases del generador contienen monóxido de carbono, el cual es una sustancia venenosa que no puede verse ni olerse.</p>	<p>Utiliser un générateur à l'intérieur PEUT VOUS TUER EN QUELQUES MINUTES. Les gaz d'échappement du générateur contiennent du monoxyde de carbone. Ceci est un poison que vous ne pouvez ni voir ni sentir.</p>
  <p>NEVER use inside a home or garage, EVEN IF doors and windows are open.</p>	 <p>Only use OUTSIDE and far away from windows, doors, and vents.</p>	 <p>NE JAMAIS utiliser dans un garage ou à l'intérieur, MÊME avec les portes et les fenêtres ouvertes.</p>
	<p>No utilize NUNCA el generador en el interior de su hogar ni en un garage, NI SIQUIERA con las puertas y ventanas abiertas.</p>	<p>À n'utiliser qu'à l'EXTÉRIEUR et à distance de toutes fenêtres, portes et ouvertures.</p>

5

NOTICE AVISO AVIS

To prevent vapor lock in the fuel tank, DO NOT turn fuel vent to OFF position until engine has cooled for at least 15 minutes.

Para prevenir el bloqueo de vapor en el tanque del combustible, NO apague la válvula de ventilación hasta que el motor se haya enfriado por 15 minutos.

Pour prévenir un blocage de vapeur dans le réservoir à carburant NE PAS tourner la mise à l'air libre carburant en position ARRÊT avant que le moteur ait refroidi durant au moins 15 minutes.

6

FOR RESIDENTS OF CALIFORNIA

WARNING: This product and the engine exhaust from this product can expose you to chemicals known to the State of California to cause cancer or cause reproductive harm. For more information go to www.P65Warnings.ca.gov.

PARA LOS RESIDENTES DE CALIFORNIA

ADVERTENCIA: Este producto y los gases del motor que se desprenden al utilizarlo pueden exponerle a sustancias químicas que se sabe que causan cáncer o causan defectos de reproducción. Para obtener más información, vaya a www.P65Warnings.ca.gov.

AVERTISSEMENT: Ce produit et les émissions du moteur de ce produit peuvent vous exposer à des produits chimiques connus pour être des cancérigènes ou des agents mutagènes en Californie. Pour plus d'informations, consultez www.P65Warnings.ca.gov.

PERIL: Failure to follow warnings, instructions and cautions may result in death or serious injury.

PELIGRO: El incumplimiento de las advertencias, las instrucciones y el manual del operador podría provocar la muerte o lesiones graves.

DANGER: Le non-respect des avertissements, des instructions et du manuel de l'opérateur entraîne la mort ou des blessures graves.

PERIL: Failure to follow warnings, instructions and cautions may result in death or serious injury.

PELIGRO: El generador podría producir una descarga eléctrica, who also avoid wet conditions. who use wet or damp conditions.

PELIGRO: El generador podría producir una descarga eléctrica who use en condiciones de humedad.

DANGER: La génératrice peut provoquer une décharge électrique who use en conditions humides.

PERIL: Had electrical gases could cause fire. Keep at least 5 ft (1.5m) clearance from any combustible or flammable materials.

PELIGRO: Los gases eléctricos pueden causar incendios. Manténgase a una distancia mínima de 5 pies (1,5 m) de los combustibles y otros materiales inflamables.

DANGER: Les gaz électrolytiques peuvent provoquer des incendies. Gardez une distance minimale de 5 mètres (15 pi) de tout combustible ou de tout matériel inflammable.

PERIL: Had electrical gases could cause fire. Keep at least 5 ft (1.5m) clearance from any combustible or flammable materials.

PELIGRO: Los gases eléctricos pueden causar incendios. Manténgase a una distancia mínima de 5 pies (1,5 m) de los combustibles y otros materiales inflamables.

DANGER: Les gaz électrolytiques peuvent provoquer des incendies. Gardez une distance minimale de 5 mètres (15 pi) de tout combustible ou de tout matériel inflammable.

PERIL: Had electrical gases could cause fire. Keep at least 5 ft (1.5m) clearance from any combustible or flammable materials.

PELIGRO: Los gases eléctricos pueden causar incendios. Manténgase a una distancia mínima de 5 pies (1,5 m) de los combustibles y otros materiales inflamables.

DANGER: Les gaz électrolytiques peuvent provoquer des incendies. Gardez une distance minimale de 5 mètres (15 pi) de tout combustible ou de tout matériel inflammable.

NOTICE: Operate above and transport on firm level surface.

AVISO: Operar, transportar y almacenar en una superficie firme y nivelada.

AVIS: Faire fonctionner, transporter et stocker sur une surface ferme et nivelée.

7

NOTICE AVISO AVISO

80 cc	12.9fl.oz (380ml)
171 cc	20.4fl.oz (600ml)
193 cc	26.4fl.oz (780ml)

Add lubricant to full mark to start. Engine will not start or will shut off if sensor detects low lubricant. • Ajuster de lubrifiant jusqu'au repère de remplissage pour démarrer. Le moteur ne démarre pas ou s'éteint si le capteur détecte le niveau de lubrifiant faible. • Añadir lubricante hasta la marca de lleno para arrancar. El motor no arranca o se apaga si sensor detecta el nivel de lubricante de baja.

FEATURES AND CONTROLS

Control Panel

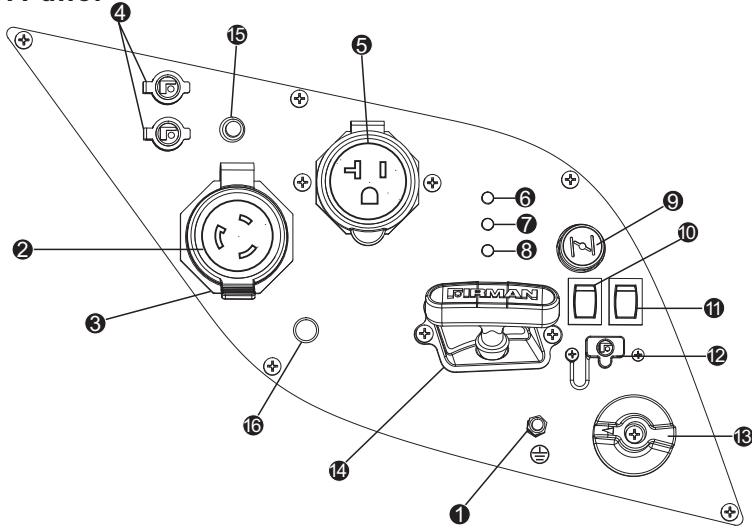

NOTICE Total power drawn from all receptacles must not exceed the data decal rating.

1. **Ground Terminal** - Consult an electrician or authority having jurisdiction for local grounding requirements.

2. **120V, 30A Receptacle** - NEMA L5-30R

A maximum of 14.2 Amps current may be drawn from this receptacle.

3. **Outlet Cover** - Protect the receptacles from dust and debris.

4. **Parallel Operation Outlets** - These outlets are used for connecting two FIRMAN inverter generators for parallel operation. A FIRMAN parallel kit(optional equipment) is required for parallel operation.

5. **120V, 20A** - NEMA 5-20R (Not GFCI protected)

A maximum of 14.2 Amps current may be drawn from this duplex receptacle.

6. **Output Ready Indicator Light** - Remains "ON" during normal operating conditions. Shuts "OFF" when generator is overloaded. The green AC Power Indicator Light comes on when the engine starts and generates power.

7. **Overload Indicator Light** - This light turns "ON" when the generator is overloaded and will cut power to the receptacles. If the engine overload indicator light comes on, the generator's wattage / amperage capacity has been exceeded by connected electrical devices. When this occurs, the green AC Power Indicator Light(Item 6) will go off. The engine will continue to run, but the red Engine Overload Indicator Light will stay on and power will no longer be supplied to connected electronic devices.

8. **Oil Warning Indicator Light** - Check oil level when this light turns "ON". Engine will not run when indicator is lit. When the oil falls below the minimum level, the oil warning indicator light comes on and the engine stops automatically. The engine will not start until the proper amount of oil is in the crank case.

9. **Choke Knob** - Used to start a cold engine.

FEATURES AND CONTROLS

10. Economy Control Switch – The Economy Control switch can be activated in order to minimize fuel consumption and noise while operating the unit during times of reduced electrical output, allowing the engine speed to idle during periods of non-use. The engine speed returns to normal when an electrical load is connected. When the economy switch is off, the engine runs at normal speed continuously.

11. Engine Switch – Flip the switch to the “**ON**”(I) position and pull the recoil starter to start the generator. Turn to the “**OFF**”(O) position to turn off the generator.

12. DC 5V 2.1A USB Outlet

13. Fuel Valve Knob

14. Recoil Stater

15. Circuit Breakers – The receptacles are protected by AC circuit protectors. If the generator is overloaded or an external short circuit occurs, a circuit protector may trip. If tripping occurs, disconnect all electrical loads and determine the cause before attempting to continue using the generator. Reset any tripped circuit protectors.

If multiple receptacles are used at the same time, the total current must be kept with-in the portable generator data decal rating.

16. CO Alert™ Carbon Monoxide (CO) Shutdown Indicator Light – Indicates the engine shutdown due to carbon monoxide accumulation around the generator or a CO Alert system fault occurred.

OPERATION

1. Location



DANGER! Engine exhaust contains carbon monoxide, a poisonous gas that could kill you in minutes. You CANNOT smell it, see it, or taste it. Even if you do not smell exhaust fumes, you could still be exposed to carbon monoxide gas.

- Operate portable generator only outdoors, at least 20 ft. (6 m) from occupied spaces with exhaust pointed away to reduce the risk of carbon monoxide accumulating.
- Install battery-operated carbon monoxide alarms or plug-in carbon monoxide alarms with battery back-up according to the manufacturer's instructions. Smoke alarms cannot detect carbon monoxide gas.
- Do not run this portable generator inside homes, garages, basements, crawlspaces, sheds, or other partially-enclosed spaces even if using fans or opening doors and windows for ventilation. Carbon monoxide can quickly build up in these spaces and can linger for hours, even after this product has shut off.
- If you start to feel sick, dizzy, weak or your home's carbon monoxide alarm sounds, get to fresh air right away. Call emergency services. You may have carbon monoxide poisoning.

Carbon Monoxide Alarm(s)

Install carbon monoxide alarms inside your home. Without working carbon monoxide alarms, you will not realize you are getting sick and dying from carbon monoxide poisoning.

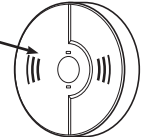

Prevent Carbon Monoxide (CO) Poisoning

Use outdoors at least 20 ft. (6 m) from any home.
Point exhaust away from all homes and occupied spaces.
Install CO alarms inside your home.



20 ft. (6 m) min.

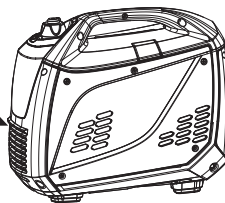

To better educate yourself about all carbon monoxide risks, go to www.takeyourgeneratoroutside.com.

Reduce Risk of Fire



WARNING! Exhaust heat/gases could ignite combustibles, structures or damage fuel tank causing a fire, resulting in death or serious injury.

- Keep portable generator at least 5 ft. (1.5 m) from any structure, trees or vegetation over 12 in. (30 cm) in height.
- Select an outdoor site that is dry and protected from the weather. Do not move portable generator indoors to protect it from the weather.
- Do not locate the portable generator under a deck or other similar structure that may confine heat and airflow.

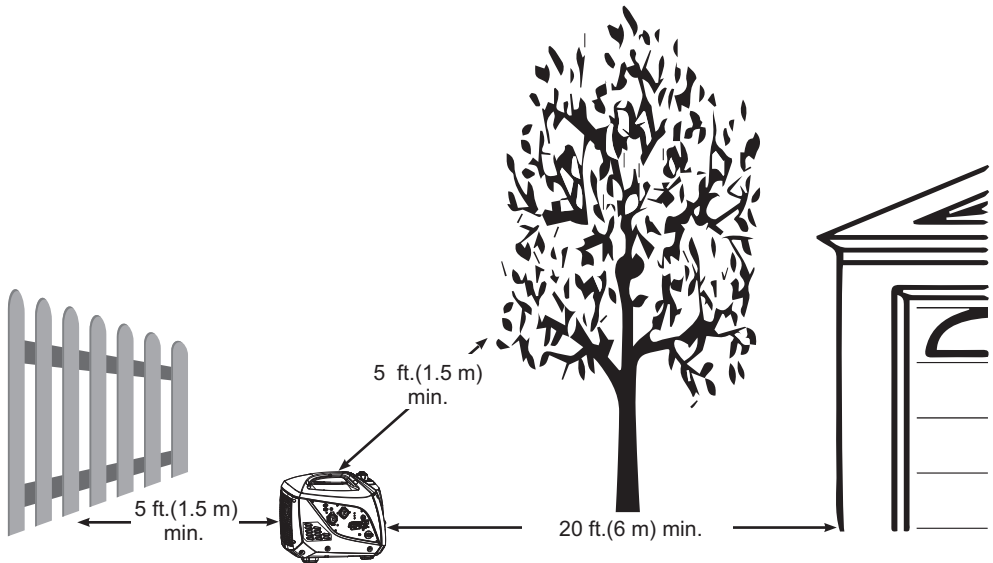

OPERATION

2. Oil and Gasoline

Add Engine Oil

We recommend using FIRMAN SAE 10W-30 API SJ oil for best performance. Other high-quality detergent oils (API SJ or higher) are acceptable. Do not use special additives. Ambient temperature determines the proper oil viscosity for the engine. Use the chart to select the proper oil for the outdoor temperature range expected.

NOTICE Do not attempt to crank or start the engine before it has been properly filled with the recommended type and amount of oil. Damage due to operation with no oil will void your warranty.

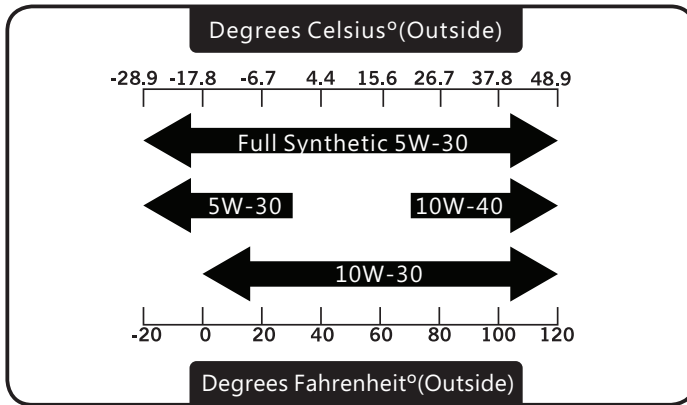

1. Place generator on a flat, level surface.
2. Loosen the cover screw and remove the maintenance cover.
3. Clean area around oil fill and remove yellow oil fill cap/dipstick.
4. Wipe dipstick clean.

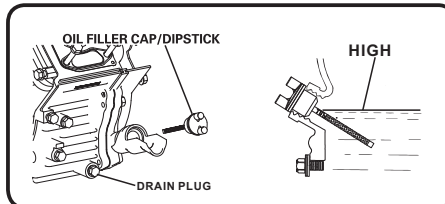
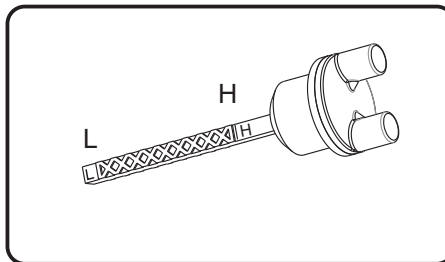

5. Using oil funnel, slowly pour contents of provided oil bottle into oil fill opening until oil reaches upper limit "H" mark on the dipstick. Be careful not to overfill. Overfilling could cause engine starting problems or engine damage.

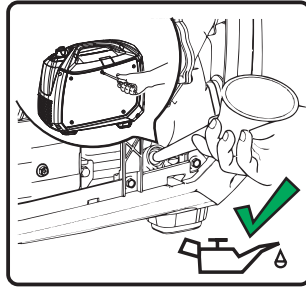

6. Replace oil fill cap/dipstick and fully tighten.

7. Reinstall maintenance cover and tighten screws.

8. Oil level should be checked prior to each use or at least every 8 hours of operation. Keep oil level maintained.

Low Oil Shutdown

The portable generator is equipped with a low oil shutdown. If the oil level drops below the minimum required level, a sensor will activate an internal switch stopping the engine. If the engine shuts off and the oil level is within specifications, check to see if generator is sitting at an angle. Place portable generator on an even surface to correct this. If engine fails to start, the oil level may not be high enough to deactivate the internal low oil level switch. Make sure the sump is completely full of oil to the upper limit (H). Do not operate engine until oil level issue is corrected. Contact Firman customer service.

Add Gasoline



WARNING! Fuel and its vapors are extremely flammable which could cause burns or fire resulting in death or serious injury.

- Turn generator engine OFF and let it cool at least 2 minutes before removing fuel cap.
- Do Not refuel or move generator when engine is running.
- Move generator outdoors prior to adding or draining fuel
- Keep fuel away from any ignition sources.
- Do not overfill tank, allow space for fuel expansion.
- If any fuel spills, wait until it evaporates before starting engine
- Check and replace fuel lines, tank, cap, and fittings prior to each use if any damage or leaks are found.

Fuel must meet these requirements:

- Clean, fresh, unleaded gasoline with a minimum of 87 octane.
- For high altitude use, see Operation at High Altitude.
- Gasoline with no more than 10% ethanol is acceptable.



OPERATION

NOTICE Do not mix oil in gasoline or modify engine to run on alternate fuels not described in this manual. Use of unapproved fuels could damage engine and will not be covered under warranty.

1. Clean area around fuel fill cap, remove cap.
2. Slowly add unleaded fuel to fuel tank. Be careful not to fill above the RED fuel level indicator. This allows adequate space for fuel expansion.

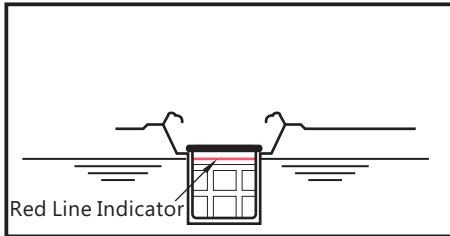

3. Install fuel cap and let any spilled fuel evaporate before starting engine.

Operation at High Altitude

At altitudes over 5,000 feet(1524 meters), a minimum 85 octane gasoline is acceptable. Engine power and generator output will be reduced approximately 3.5% for every 1000 feet (305 m) of elevation above sea level. High altitude may cause hard starting, increased fuel consumption and sparkplug fouling. To operate at high altitudes FIRMAN can provide a high altitude carburetor main jet. The alternative main jet and installation instructions can be obtained by contacting Customer Support.

	80cc	Altitude
Altitude main jet 1	317717005	3000-6000Feet
Altitude main jet 2	317717006	6000-8000Feet

NOTICE Operation using an alternative main jet at elevations lower than the recommended minimum altitude can damage the engine. For operation at lower elevations, the standard main jet supplied must be used. Operating the engine with the wrong main jet may increase exhaust emissions, fuel consumption and reduce performance.

Operation at High Ambient conditions

Your Firman Power Equipment product is designed and rated for continuous operation at ambient temperatures up to 104°F (40°C). The generator may be operated at temperatures ranging from 5°F(-15°C) to 122°F(50°C) for short periods. If the generator is exposed to temperatures outside this range during storage, the generator should be brought back within this range before operation. When operated above 77°F(25°C) there may be a decrease in power. Maximum wattage and current are subject to and limited by such factors as ambient temperature, altitude, engine conditions etc.

3.Starting the Generator

1. Before starting the generator, check for loose or missing parts and for any damage which may have occurred during shipment. Ensure spark plug, muffler, fuel cap, and air cleaner are all in place.
2. Move portable generator outdoors to safe operating location at least 20 ft. (6m) from any occupied spaces.
3. Disconnect all electrical loads from the generator. Never start or stop the generator with electrical devices plugged in.

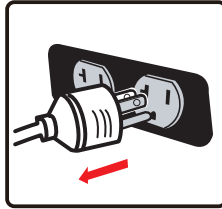

4. Turn the fuel cap vent lever to the "ON"(I) position.

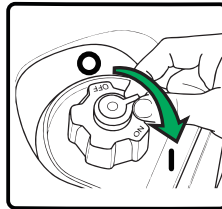

5. Turn the fuel valve to the "ON" (I) position.

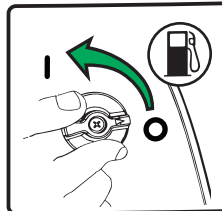

6. Pull the choke knob to the "CHOKE" position.

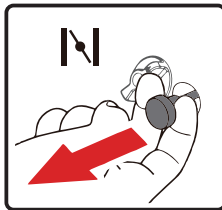

OPERATION

7. Flip the engine switch to the "ON" (I) position.

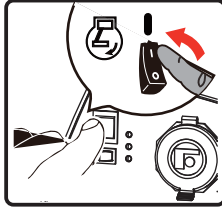

8. Pull the starter cord slowly until resistance is felt and then pull rapidly to start the engine.

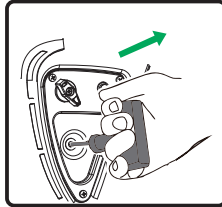

9. Push the choke knob to the "RUN" position.

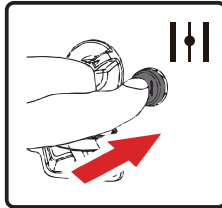

10. Allow portable generator to run at no load for a few minutes to stabilize before plugging in any electrical devices.

NOTICE If engine starts but fails to run, or if portable generator shuts down during operation, check oil level. See Low Oil Shutdown section for more information.

4. Connecting Electrical Loads

This portable generator has been pretested and adjusted to handle its full capacity. The voltage is regulated using an automatic voltage regulator (AVR). Readjusting the AVR will void warranty.



WARNING! Generator voltage could cause electrical shock or burn resulting in death or serious injury.

- Damaged or overloaded extension cords could overheat, arc, and burn resulting death or serious injury.
- Use a ground fault circuit interrupter (GFCI) in any damp or highly conductive area, such as metal decking.
- Do not touch bare wires or receptacles.
- Do not use generator with electrical cords which are worn, frayed, bare or otherwise damaged.
- Do not operate generator in the rain or wet weather.
- Do not run indoors to avoid wet conditions.
- Do not handle generator or electrical cords while standing in water, while barefoot, or while hands or feet are wet.

1. Ensure circuit breaker on control panel is in the closed (on) position.
2. Start the generator with no electrical load attached.
3. Allow the engine to run for several minutes to stabilize.
4. Plug in and turn on the first item. It is best to attach the item with the largest load first.
5. Allow the engine to stabilize.
6. Plug in and turn on the next item.
7. Allow the engine to stabilize.
8. Repeat steps 5-6 for each additional item.

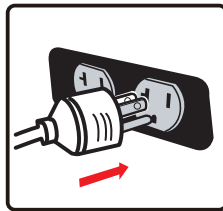

Surge Protection

There is a remote chance that voltage fluctuations may impair the proper functioning of some sensitive electronic equipment. Electronic devices, including computers and many programmable appliances may use components that are designed to operate within a narrow voltage range and may be affected by the portable generator's momentary voltage fluctuations. While there is no way to prevent all voltage fluctuations, you can take steps to protect your sensitive electronic equipment. Install a plug-in surge suppressor on the receptacles feeding your sensitive equipment. Surge suppressors come in single or multi-outlet styles. They are designed to protect against short duration voltage fluctuations.

OPERATION

CO Alert™

Carbon Monoxide (CO) Shutdown System

CO Alert automatically shuts down the engine when harmful levels of carbon monoxide accumulate around the generator or a CO Alert fault occurs. After shutdown, the CO Alert indicator light will blink for at least five minutes per the chart below.

CO Alert DOES NOT replace carbon monoxide alarms.

Install battery-powered carbon monoxide alarm(s) in your home. Don't run generator in enclosed areas.

Color	Description
Red •••••	Carbon monoxide accumulated around generator. Prior to restart move generator to an open, outdoor area 20 ft. (6 m) from occupied spaces with exhaust pointed away. Air out premises (open windows and doors) before reoccupying property. Automatic shutoff is an indication generator was improperly located. If you start to feel sick, dizzy, weak, or your homes carbon monoxide alarm sounds while using this product, get to fresh air right away. Call emergency services. You may have carbon monoxide poisoning.
Yellow •• ••	CO Alert fault occurred*. See FIRMAN authorized service dealer.

*Yellow light will blink for five seconds at the startup of generator to show CO ALERT is functioning properly.

Economy Control Switch

The Economy Control switch can be activated in order to minimize fuel consumption and noise while operating the unit during times of reduced electrical output, allowing the engine speed to idle during periods of non-use. The engine speed returns to normal when an electrical load is connected. When the economy switch is off, the engine runs at normal speed continuously.

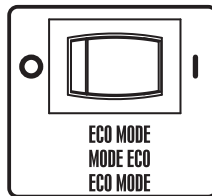

NOTICE

For periods of high electrical load or momentary fluctuations, the Economy Control Switch should be turned OFF.

5. Stopping the generator

1. Turn off and remove all electrical loads.

Never stop the generator with electrical devices plugged in and turned on.

Never stop the engine by moving the choke to the start position.

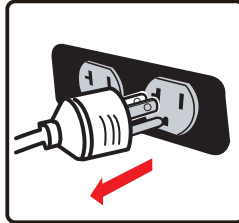

Let the generator run at no-load for one minute to stabilize internal temperatures of the engine and generator.

2. Flip the engine switch to "OFF"(O) position.

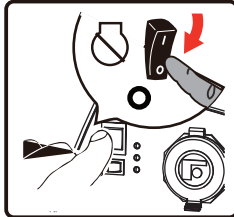

3. Turn the fuel valve to the "OFF"(O) position.

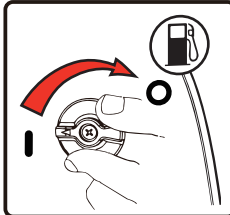

4. Turn the fuel cap vent lever to the "OFF"(O) position.

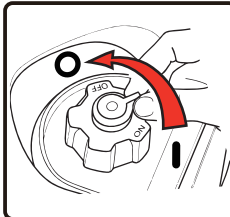

If a cover is used, do not install until unit has cooled.

NOTICE

If the engine will not be used for a period of two weeks or longer, please see the Storage section for proper engine and fuel storage.

OPERATION

Low Oil Shutdown

If the engine oil drops below a preset level, an oil switch will stop the engine. Check oil level with dipstick.

If oil level is between the **LOW** and **HIGH** mark on dipstick:

1. DO NOT try to restart the engine.
2. Contact an Authorized FIRMAN Service Dealer.
3. DO NOT operate engine until oil level is corrected.

If oil level is below the **LOW** mark on dipstick:

1. Add oil to bring level to **HIGH** mark.
2. Restart engine and if the engine stops again a low oil condition may still exist. DO NOT try to restart the engine.
3. Contact an Authorized FIRMAN Service Dealer.
4. DO NOT operate engine until oil level is corrected.

Do Not Overload Generator

Overloading a generator in excess of its rated wattage capacity can result in damage to the generator and to connected electrical devices. To prolong the life of your generator and attached devices, follow these steps to add electrical load:

1. Start the generator with no electrical load attached.
2. Allow the engine to run for several minutes to stabilize.
3. Plug in and turn on the first item. It is best to attach the item with the largest load first.
4. Allow the engine to stabilize.
5. Plug in and turn on the next item.
6. Allow the engine to stabilize.
7. Repeat steps 5-6 for each additional item.

Overload Operation

The overload indicator light will turn on when the load exceeds 1764W(approximately). If the load exceeds 1860W(approximately), the light will blink and cut power to the receptacles in 30 seconds.

How to Correct

1. Disconnect any electrical devices, and then stop the engine.
2. Reduce the total wattage of connected electrical devices until it is within the generator's rated output.
3. Inspect the Air Inlet and Control Panel for any blockage. Remove blockage if found.
4. Restart Engine.

Parallel Operation

Any two FIRMAN inverter generators with parallel ports, including two FIRMAN inverters model W01785 can be paralleled to increase the total available electrical power to 3100 Watts. A FIRMAN Parallel kit (not included) is required for parallel operation. For Kit availability, call customer Service at 1-844-347-6261 or visit: www.firmanpowerequipment.com.

MAINTENANCE SCHEDULE

ITEM	NOTES	Daily(Before operation)	Initial 25 hours	Every 50 hours	Every 100 hours (or annual)	Every 250 hours
Spark Plug	Check condition. Adjust gap and clean. Replace if necessary.				✓	
Engine Oil	Check oil level.	✓				
	Replace.		✓		✓	
Air Filter	Clean, replace if necessary.			✓		
Fuel	Clean fuel tank strainer. Replace if necessary.				✓	
Fuel Line	Check fuel hose for cracks or other damage. Replace if necessary.	✓				
Exhaust System	Check for leakage. Retighten or replace gasket if necessary.	✓				
	Check spark arrester screen. Clean/Replace if necessary.				✓	
Engine	Check adjust valve clearance. *					✓
	Clean combustion chamber. *					✓
Fittings/ Fasteners	Check. Replace if necessary.				✓	

* To be performed by knowledgeable/experienced owner or by authorized service center.

General Recommendations

Regular maintenance will improve the performance and extend the life of the generator. See any authorized dealer for service.

The generator's warranty does not cover items that have been subjected to operator abuse or negligence. To receive full value from the warranty, the operator must maintain the generator as instructed in this manual.

Some adjustments will need to be made periodically to properly maintain your generator.

All service and adjustments should be made at least once each season. Follow the requirements in the maintenanc shedule chart above.

NOTICE Once a year you should clean or replace the spark plug and replace the air filter. New spark plug and clean air filter assure proper fuel-air mixture and help your engine run at peak performance and last longer.

Maintenance - Storage

When Transporting Generator

Transport with fuel tank EMPTY or with fuel valve in OFF position.
Do not tip generator at an angle which causes fuel to spill.

ENGINE MAINTENANCE

To prevent accidental starting, remove and ground spark plug wire before performing any service.

Change Engine Oil

Change engine oil every 100 hours. (for a new engine, change oil after 25 hours.)
If you are using your generator under extremely dirty or dusty conditions, or in extremely hot weather change the oil more often.

CAUTION! Avoid prolonged or repeated skin contact with used motor oil. Used motor oil has been shown to cause skin cancer in certain laboratory animals. Thoroughly wash exposed areas with soap and water.



KEEP OUT OF REACH OF CHILDREN. DON'T POLLUTE. CONSERVE RESOURCES. RETURN USED OIL TO COLLECTION CENTERS.

- (a) Loosen the cover screws and remove the maintenance cover.
- (b) Pop up the rubber plug from below yellow draining bolt.
- (c) Remove drain bolt.
- (d) Tilt the generator on its side and allow the oil to drain completely.
- (e) Replace drain bolt.
- (f) Fill the engine with oil until it reaches the HIGH (H) level on the oil filler cap. **DO NOT OVERFILL.**
- (g) Reinstall the maintenance cover and tighten the cover screws.
- (h) Dispose of used oil at an approved waste management facility.

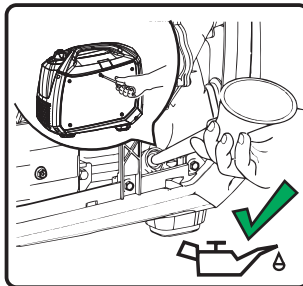

NOTICE We recommend using FIRMAN SAE 10W-30 API SJ oil for best performance. Other high-quality detergent oils (API SJ or higher) are acceptable. See *Oil and Gasoline*

Air Filter Maintenance

(a) Remove the air cleaner cover and locate the air filter plastic cover.

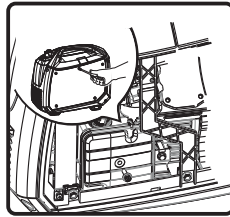

(b) Carefully remove foam air filter element and wash it with liquid detergent and water only. Squeeze dry in a clean cloth.

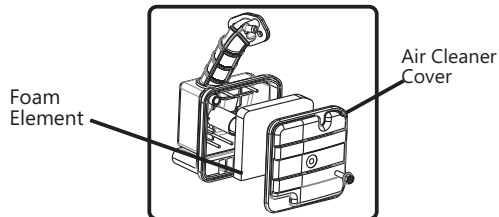

(c) Saturate foam air filter element with clean engine oil and squeeze in a clean cloth to remove excess oil.

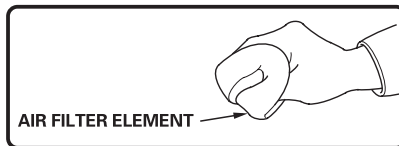

(d) Reinstall clean or new air filter element.

(e) Reattach the air filter cover.

(f) Reinstall the air cleaner cover and tighten the cover screw securely.

Spark Plug Maintenance

Changing the spark plug will help your engine start easier and run at peak performance.

(a) Remove the maintenance cover.

(b) Remove the spark plug boot.

(c) Remove spark plug using provided wrench.

Maintenance - Storage

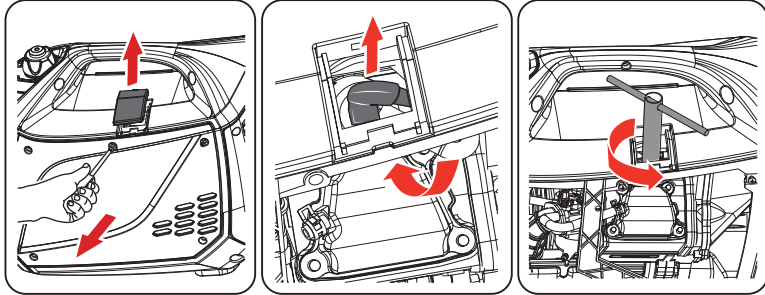

(d) Inspect spark plug for damage and clean with a wire brush before reinstalling. Replace if damaged.

(e) Adjust the electrode gap to 0.028 - 0.031 in. (0.7 - 0.8 mm).

(f) Seat spark plug in position and thread by hand to prevent cross threading.

(g) Tighten plug with provided wrench and put the spark plug boot back on spark plug.

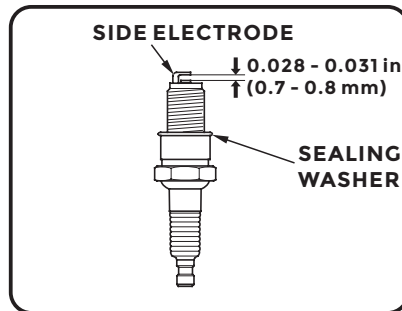

SPARK PLUG: NGK BPR6HS, Champion RL87YC, Torch E6RTC or equivalent.

Maintenance Valve Clearance

Intake: 0.003 - 0.005 in. (0.08 - 0.12 mm)

Exhaust: 0.003 - 0.005 in. (0.08 - 0.12 mm)

Muffler and Spark Arrester



WARNING! Contact with muffler area could cause burns resulting in serious injury.

- Do not touch hot parts.
- It is a violation of California Public Resource Code, Section 4442, to use or operate the engine on any forest-covered, brush-covered, or grass-covered land unless the exhaust system is equipped with a spark arrester, as defined in Section 4442, maintained in effective working order. Other states or federal jurisdictions may have similar laws, reference Federal Regulation 36 CFR Part 261.52.

Inspect Muffler and Spark Arrester

1. Remove the maintenance cover and inspect the muffler for cracks, corrosion, or other damage.
2. Loosen the spark arrester screws, remove the spark arrester cover, and with a thin blade screwdriver remove the spark arrester.

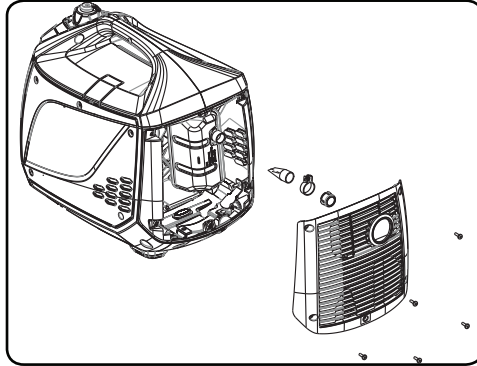

3. Carefully remove the carbon deposits from the spark arrester screen with a wire brush.

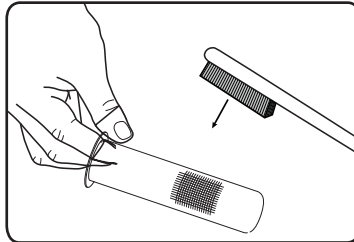

4. Replace the spark arrester if it is damaged. If replacement parts are required, make sure to use only FIRMAN original equipment replacement parts.
 5. Position the spark arrester in the muffler and attach with the screws.
- NOTICE** Failure to clean or replace spark arrester may result in decreased engine performance.

GENERATOR MAINTENANCE

Run the generator at least 30 minutes every month.

Make certain that the portable generator is kept clean and dry.

Do not expose the unit to excessive dust, dirt, moisture or corrosive vapors.

Do not insert any objects through cooling slots.

Before each use inspect underneath the generator for signs of oil or fuel. Clean any accumulated debris. Keep area around muffler free from any debris. Use a soft bristle brush to remove dirt or caked on oil. Use a damp cloth to clean all exterior surfaces.

Long Term Storage

It is important to prevent gum deposits from forming in essential fuel system components such as the carburetor, fuel hoses or tank during storage. Ethanol-blended fuels (called gasohol, ethanol or methanol) attract moisture, which leads to separation and formation of acids during storage. Acidic gas can damage the fuel system of an engine while in storage.

When the generator set is being stored for more than one month, follow these instructions to avoid engine problems:



WARNING! Fuel and its vapors are extremely flammable which could cause burns or fire resulting in death or serious injury.

Do not store fuel near any ignition sources.

When draining fuel move generator outdoors and use a commercially available non-conductive vacuum siphon. Fuel must be drained into an approved container.

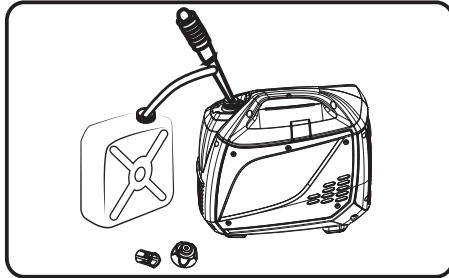

1-Treat any stored fuel with fuel stabilizer.

2-When storing generator with gasoline in fuel tank, operate the engine for 5-10 minutes to circulate treated fuel into fuel lines and carburetor before shutdown.

3- There is no need to drain gasoline from the generator fuel tank if fuel stabilizer is added.

4-FUEL STARVATION: If you elect to drain fuel tank move generator outdoors. Once fuel tank is drained turn fuel valve to on position. Start and run the portable generator outdoors until engine stops from lack of gasoline. This will drain remaining gasoline from tank, fuel lines, and carburetor.

5-Always turn fuel valve to OFF position prior to storage.

6-Allow the portable generator to cool before cleaning and storage.

7-Change oil .

8-Remove spark plug boot and spark plug. Pour about one teaspoon of engine oil through the spark plug hole, then slowly pull the recoil starter several times to distribute the oil in the cylinder. Pull recoil slowly until resistance is felt. This will close the valves so no moisture enters the engine cylinder. Reinstall the spark plug and attach the spark plug boot.

9-Cover the portable generator and store in a clean, dry place out of direct sunlight and away from any ignition sources.

Any damage or hazards caused by using improper fuel, improperly stored fuel, and/or improperly formulated stabilizers, are not covered by manufacturer's warranty.

Do not store gasoline from one season to another season.

Troubleshooting - Specifications

TROUBLE SHOOTING

Problem	Cause	Correction
Engine is running, but no AC output is available.	<ol style="list-style-type: none"> 1. Circuit breaker is open. 2. Fault in generator. 3. Poor connection or defective cord set. 4. Connected device is bad. 	<ol style="list-style-type: none"> 1. Reset circuit breaker. 2. Contact authorized service facility. 3. Check and repair. 4. Connect another device that is in good condition.
Engine runs good at no-load but "bogs down" when loads are connected.	<ol style="list-style-type: none"> 1. Short circuit in a connected load. 2. Engine speed is too slow. 3. Generator is overloaded. 4. Shorted generator circuit. 5. Clogged or dirty fuel filter. 	<ol style="list-style-type: none"> 1. Disconnect shorted electrical load. 2. Contact authorized service facility. 3. See Don't Overload Generator 4. Contact authorized service facility. 5. Clean or replace fuel filter.
Engine will not start; starts and runs rough or shuts down when running.	<ol style="list-style-type: none"> 1. Engine switch set to OFF (O) position. 2. Fuel shutoff lever is in OFF (O) position. 3. Low oil level. 4. Dirty air cleaner. 5. Out of fuel. 6. Stale fuel. 7. Spark plug wire not connected to spark plug. 8. Bad spark plug. 9. Water in fuel. 10. Flooded. 11. Excessively rich fuel mixture. 12. Intake valve stuck open or closed. 13. Engine has lost compression. 14. Clogged or dirty fuel filter. 	<ol style="list-style-type: none"> 1. Set engine switch to ON (I) position. 2. Move fuel shutoff lever to ON (I) position. 3. Fill crankcase to proper level or place generator on level surface. 4. Clean or replace air cleaner. 5. Fill fuel tank. 6. Drain fuel tank and carburetor; fill with fresh fuel. 7. Connect wire to spark plug. 8. Replace spark plug. 9. Drain gas tank and carburetor; fill with fresh fuel. 10. Wait 5 minutes and re-crank engine. 11. Contact authorized service facility. 12. Contact authorized service facility. 13. Contact authorized service facility. 14. Clean or replace fuel filter.
Engine lacks power.	<ol style="list-style-type: none"> 1. Load is too high. 2. Dirty air filter. 3. Clogged or dirty fuel filter. 4. Clogged spark arrester. 	<ol style="list-style-type: none"> 1. Don't Overload Generator 2. Replace air filter. 3. Clean or replace fuel filter. 4. Clean or replace spark arrester.
Engine "hunts" or falters.	<ol style="list-style-type: none"> 1. Carburetor is running too rich or too lean. 2. Clogged or dirty fuel filter. 	<ol style="list-style-type: none"> 1. Contact authorized service facility. 2. Clean or replace fuel filter.
Engine shuts down when running.	<ol style="list-style-type: none"> 1. Out of fuel. 2. Dirty air cleaner. 3. Low oil level. 	<ol style="list-style-type: none"> 1. Fill fuel tank. 2. Clean or replace air cleaner. 3. Fill crankcase to proper level or place generator on level surface.
Engine shuts down and yellow CO fault light blinking.	<ol style="list-style-type: none"> 1. CO system fault 	<ol style="list-style-type: none"> 1. Contact authorized FIRMAN service facility.

For all other issues, contact authorized dealer or Firman customer service.

SPECIFICATIONS

Model	W01785
Starting Watts	2100
Running Watts*	1700
Rated AC Voltage	120V
Rated Frequency	60Hz
Phase	Single
Voltage Regulator	Digital
Total Harmonic Distortion(THD)	<3%
Power Factor	1
Alternator Type	Magneto Inductor
Engine	FIRMAN
Engine Type	Single Cylinder, 4-Stroke OHV Air Cooled
Displacement	80cc
Low Oil Shutdown	Yes
Ignition System	Breakless Ignition Type, Flywheel Magneto
Starting System	Recoil
Fuel	Unleaded Automotive Gasoline
Capacity Fuel Tank	0.9Gal(3.4L)
Lubricating Oil Capacity	12.9oz(0.38L)
Carburetor Type	Float
Air Cleaner	Polyurethane Type
P.T.O. Shaft Rotation	Counter Clockwise (Facing P.T.O.)
Oil Type	See "Add Engine Oil" Section
AC Grounding System	Neutral Floating

*Generator certified in accordance with CSA (Canadian Standards Association) standard C22.2No. 100-14, Motors and Generators and complies with PGMA (Portable Generator Manufacturers' Association) standard ANSI/PGMA G300-2018, Safety and Performance of Portable Generators.

PARTS DIAGRAM AND PART LIST
W01785 PARTS DIAGRAM

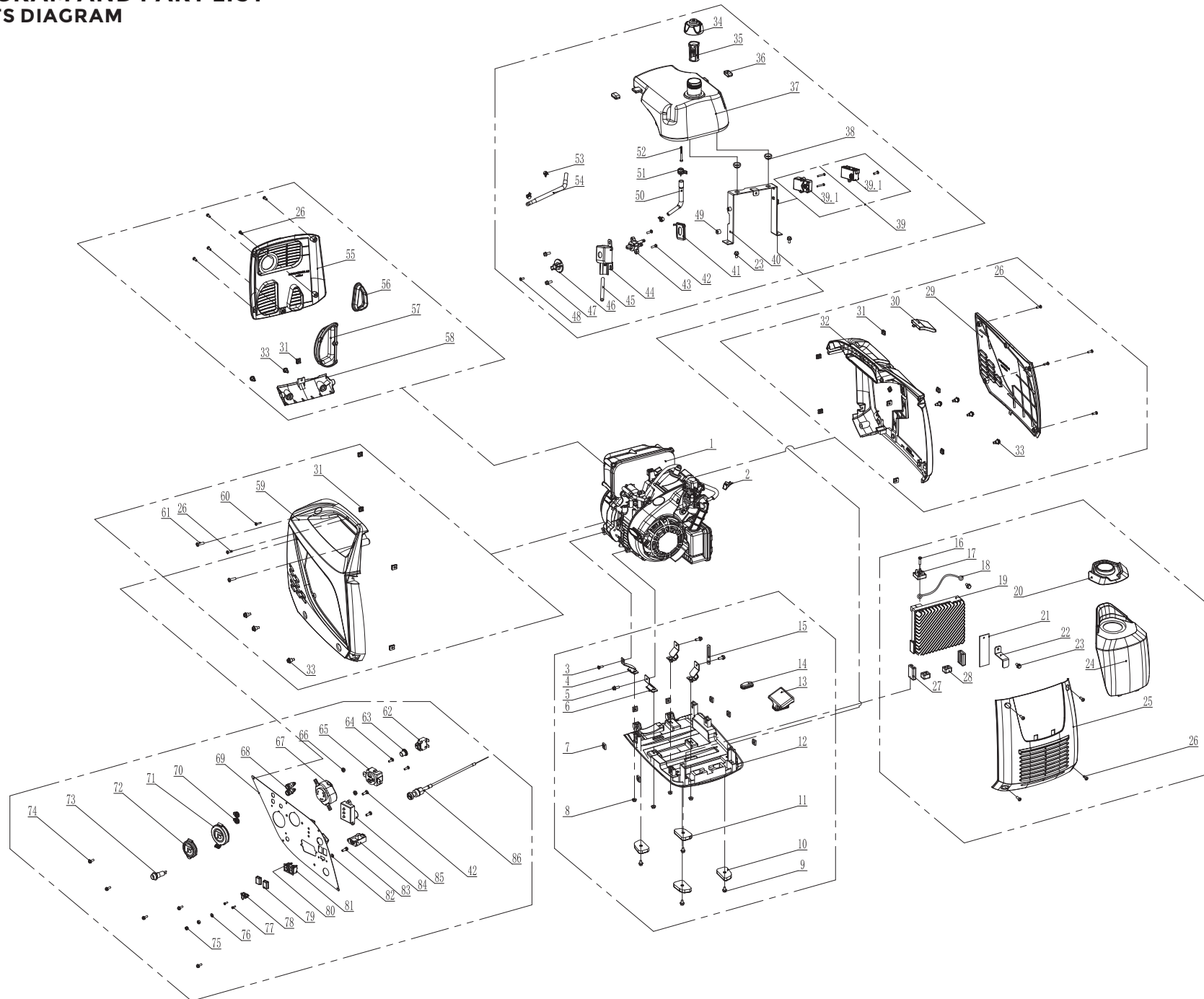

80cc ENGINE PARTS DIAGRAM

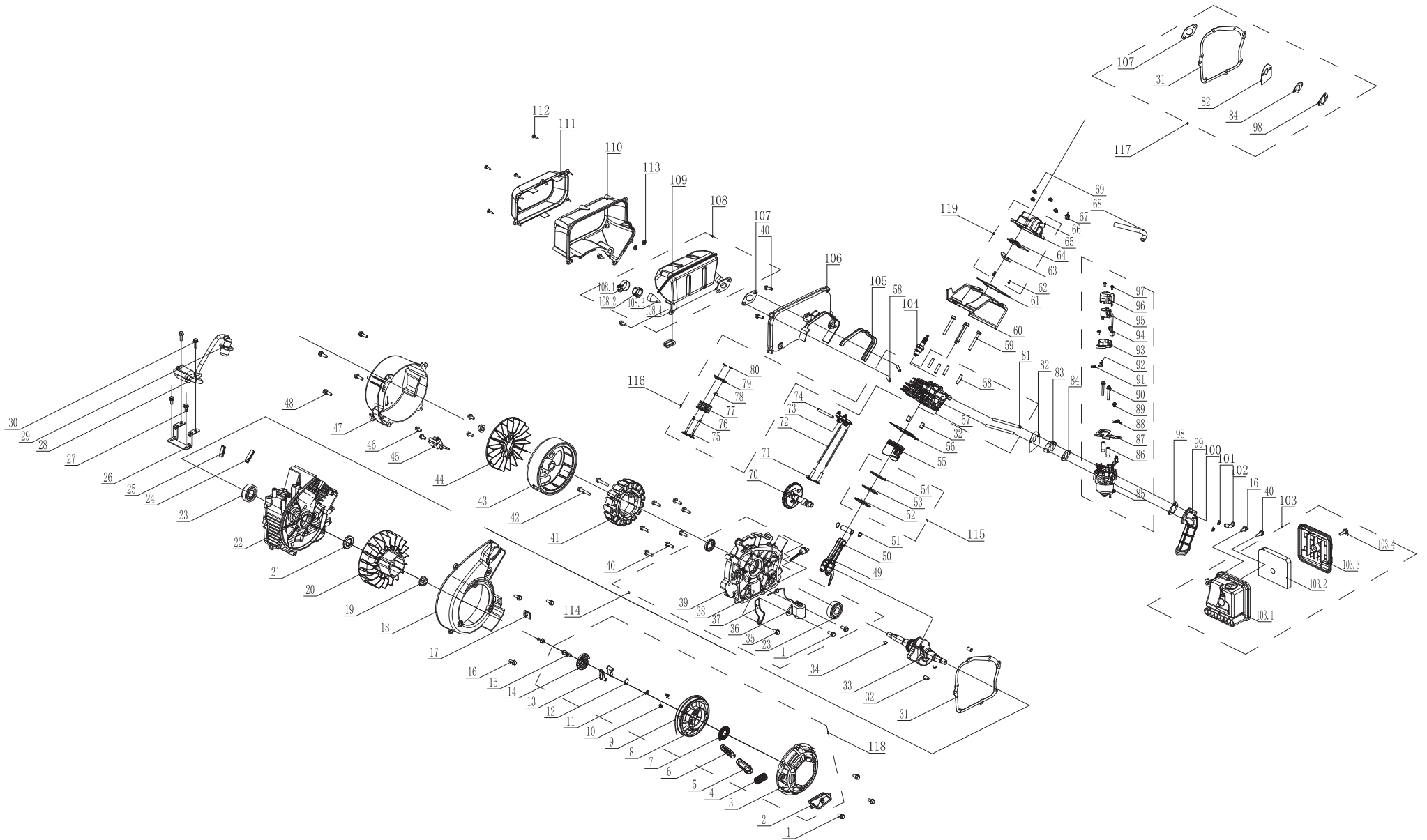

Parts Diagrams - Parts Lists - Wiring Diagram

W01785 Portable Generator

NO.	Part Number	Description	Qty.	NO.	Part Number	Description	Qty.
1	316465501	Engine Subassembly	1	55	317713525	Left Side Cover Assy	1
2	317723586	Oil Nozzle	1	56	317723526	Plug II	1
3	317713515	Screw M6×15	1	57	317723527	PlugI	1
4	317713514	Isolator	1	58	317713523	Front Bridge	1
5	317713513	Bolt M6×15	3	59	317713522	Front Cover Assy	1
6	317713512	Isolator	3	60	330713523	Screw St4.2×16	1
7	317713506	Nut M6	7	61	336718363	Screw M6×20	2
8	336718314	Nut M6	4	62	330713594	Circuit Breaker Amp 20A	1
9	317713508	Bolt M6×12	4	63	336755005	Circuit Breaker Cover	1
10	317713509	Base Mounting	2	64	336718383	Screw M4×14	2
11	317713510	Base Mounting	2	65	317713581	Socket 5-20R	1
12	317713507	Base Assy	1	66	330713596	Nut M4	2
13	317713504	Passageway, Air Cleaner	1	67	317713580	Socket L5-30R	1
14	317713505	Passageway, Electric Machinery	1	68	317713562	Parallel Terminal	2
15	330723528	Wire Clip	1	69	316415500	Control Panel Assy	1
16	336718396	Screw M5×20	1	70	317713563	Outlet Cover (parallel Terminal)	2
17	317713539	Bridge Rectifier	1	71	317713578	Outlet Cover L5-30R	1
18	316755500	Ground Wire	1	72	317713579	Outlet Cover 5-20R	1
19	316718302	Control Unit	1	73	336755002	Co Indicator Light	1
20	317713500	Fuel Guide Plate	1	74	336718383	Screw M14×14	5
21	316725500	Rubber, Support	1	75	336713577	Nut M5	2
22	317713541	Clip of Control Unit	1	76	317713567	Flat Washer Φ5	1
23	317713537	Bolt M6×12	4	77	317713560	Screw M3×10	2
24	317713501	Cover, Top	1	78	317713559	Outlet Cover (USB)	1
25	317713503	Right Side Cover Assy	1	79	316735503	Engine Switch Cover	2
26	336718397	Screw M5×14	15	80	317718305	Economic Switch	1
27	317713543	Rubber of Control Unit	2	81	317718303	Engine Switch	1
28	317713542	Mounting of Control Unit	2	82	317713569	Serrated Lock Washers 5	1
29	317713532	Maintenance Cover	1	83	336718345	Bolt M5×12	1
30	317713531	Maintenance Cover	1	84	317713556	USB	1
31	330713525	Cage Nut M5	13	85	316715502	Ignition Assy.	1
32	317713530	Supporter, Back Cover	1	86	317713548	Chock Cable Assy.	1
33	330713527	Bolt M6×16	9				
34	317713529	Fuel Tank Cap Comp	1				
35	317713528	Fuel Filter	1				
36	317713526	Mounting, Fuel Tank	2				
37	317713527	Fuel Tank Assy	1				
38	317713535	Buffer	2				
39	316755501	CO Control Module	1				
40	316715500	Bracket, Fuel Tank	1				
41	317713544	Fuel Canister, Cover	1				
42	336718397	Screw M5×14	2				
43	317713552	Fuel Cock Comp.	1				
44	317713545	Fuel Canister, Base	1				
45	317713547	Tube	1				
46	317718300	Fuel Cock Knob	1				
47	317718304	Bolt M6×20	2				
48	317713550	Screw M4×10	1				
49	317718302	Bush	1				
50	316725501	Hose, Fuel	1				
51	316715503	Tube Clip Φ13.5×10	1				
52	317713579	Filter Tube	1				
53	330713508	Tube Clip Φ10.5×b8	3				
54	316725502	Hose, Fuel	1				

Parts Diagrams - Parts Lists - Wiring Diagram

FIRMAN 80cc Engine

NO.	Part Number	Description	Qty.	NO.	Part Number	Description	Qty.
1	317723500	Bolt M6x12	9	65	316715512	Air Shroud,cylinder	1
2	316715529	Guide,rope	1	66	316715511	Breather Tube	1
3	316715528	Case Comp.,Recoil Starter	1	67	393713040	Clamping	1
4	316725508	Corrugated Pipe	1	68	317723555	Breather Pipe	1
5	316725507	Recoil Starter Knob	1	69	336718314	Nut M6	4
6	316715527	Handle Croe	1	70	317723540	Camshaft Comp.	1
7	316715526	Spring,starter Return	1	71	317723541	Valve Lifter	2
8	316715525	Pulley, recoil Starter	1	72	317723542	Push Rod	2
9	316725506	Cord	1	73	317723576	Arm, valve Rocker	2
10	316715524	Spring,patchet	2	74	317723577	Shaft,screw Rocker	1
11	316715523	Gasket, Pulley,Recoil Starter	1	75	317723582	Valve,intake	1
12	316715522	Retaining Ring ϕ 14	1	76	317723583	Valve,e×haust	1
13	316715521	Patching,starter	2	77	317723581	Spring, valve	2
14	316715520	Pawl Guide	1	78	317723580	Oil Seal, valve	1
15	316715519	Screw,pawl Guide	1	79	317723579	Ret., valve Spring	2
16	317723502	Bolt M6x15	5	80	317723578	Lock Clip, Valve	2
17	317723503	Nut	1	81	317723562	Carburetor Bolt	2
18	317723504	Fan Cover	1	82	317723563	Gskt,insulator	1
19	317723505	Nut M12	2	83	317723564	Insulator,carb.	1
20	317723505	Cooling Fan	1	84	317723565	Gskt,carb	1
21	317723507	Oil Seal 20x35x5	2	85	316415505	Carb. Assy.	1
22	317723508	Crankcase Comp	1	86	316715510	Strut	2
23	317723511	Bearing 6204	2	87	316715509	Support,Stepper Motor	1
24	317723512	Protector Cover Seal 2	1	88	330723585	Clamp Board,Choke Control Line	1
25	317723513	Protector Cover Seal 1	1	89	380713562	Screw&washer Assy M5x8	1
26	317723588	Bracket,Ignition Assy.	1	90	316715505	Screw&washer Assy M5x35	2
27	317723500	Bolt M6x12	2	91	330723581	Spring,connector	1
28	317723509	Ignition Assy.	1	92	316715508	Connector,throttle Valve Axis	1
29	316725505	Plug	1	93	316725504	Stepper Motor Base	1
30	317723510	Bolt M6x20	12	94	330723588	Screw/Washer Assembly M4x8	2
31	317723517	Crankcase Gasket	1	95	330723589	Stepper Motor,Throttle Valve	1
32	317723516	Dawl Pin	4	96	330723591	Cover,stepper Motor	1
33	317723514	Crank Shaftassy	1	97	316715504	Screw/washer Assembly M3x6	2
34	317723515	Key	2	98	317723567	Gskt,air Cleaner	1
35	317723585	Bolt M6x8	1	99	317723568	Pipe,air Cleaner	1
36	317723518	Oil Level Switch	1	100	316715507	Clamp Board,Air Cleaner	1
37	317723519	Oil Level Switch Plate	1	101	336713517	Nut M6	2
38	317723584	Oil Dipstick Assy	1	102	317723569	Connector.,Breather Pipe	1
39	317723520	Crankcase Cover	1	103	316415504	Air Cleaner Case Assy	1
40	317723510	Bolt M6x20	10	103.1	317723570	Case,air Cleaner Comp.	1
41	316755502	Stator Comp.	1	103.2	317723571	Element	1
42	317723524	Bolt M6x35	2	103.3	317723572	Case,air Cleaner	1
43	316718301	Rotor Comp.	1	103.4	317723573	Bolt	1
44	317723534	Generator Fan	1	104	317723543	Spark Plug	1
45	317723521	Trigger Assy	1	105	317723553	Muff. Protector Seal	1
46	336718338	Bolt M6x12	2	106	317723551	Protector Muff. Side	1
47	317723529	End Cover	1	107	317723550	Auspuffdichtung	1
48	399715714	Bolt M6x22	4	108	316715506	Muff.,assy.	1
49	317723537	Conn. Rod Assy.	1	108.1	317723530	Clamp	1
50	317723536	Piston Pin	1	108.2	317723531	Spark Arrester Base	1
51	317723535	Piston Pin Clip	2	108.3	317723532	Spark Arrester Base	1
52	316715518	Ring Set, Oil	1	108.4	316715530	Muff Comp	1
53	316715517	Ring, The Second	1	109	317723533	Rubber Seal	1
54	316715516	Ring, The First	1	110	317723547	Muff. Protector Assy.middle	1
55	317723539	Piston	1	111	317723546	Muff. Protector Assy. (R)	1
56	317723561	Gasket,cylinder	1	112	317713521	Screw St 4.8x17	4
57	317723560	Cylinder Head Comp.	1	113	336718314	Nut M6	2
58	317723544	Stud Bolt M6x27	6	114	316415501	Crankcase Cover	1
59	316715515	Bolt M6x50	4	115	316415502	Piston Rings Set	1
60	317723558	Air Shroud,Cylinder Comp.	1	116	316415503	Cylinder Head	1
61	317723557	Cylinder Cover Gasket	1	117	316425501	Gasket,assy	1
62	330723590	Screw M3x6	3	118	317723501	Starter Assy.	1
63	316715514	Filter	1	119	317723556	Cylinder head Cover Assy	1
64	316715513	Cylinder Cover	1				

Wiring Diagram

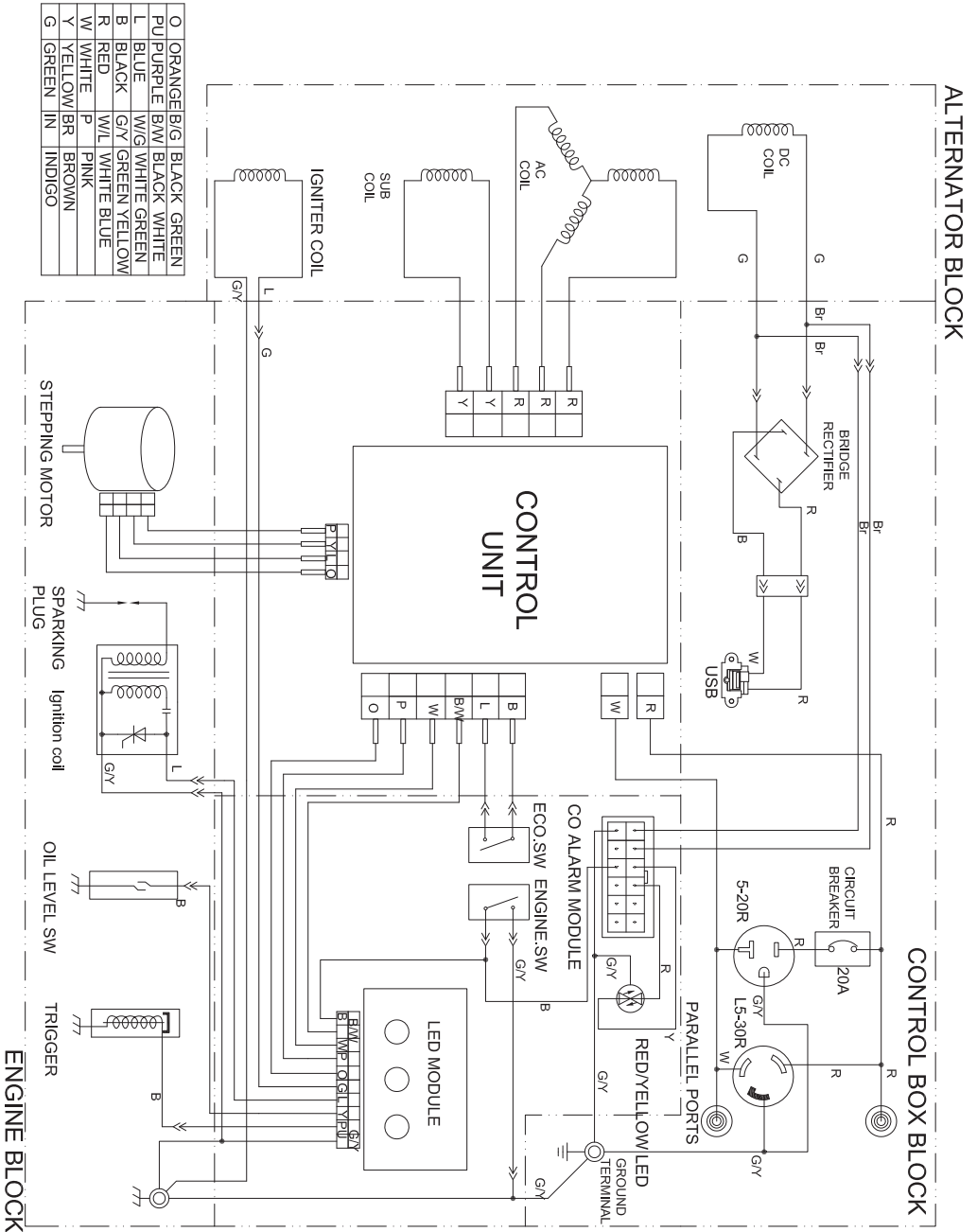

Service - Warranty

SERVICE INFORMATION CONTACT FIRMAN PRODUCT SERVICE DEPARTMENT AT 1-844-347-6261 or at www.firmanpowerequipment.com to obtain warranty service information or to order replacement parts or accessories.

HOW TO ORDER REPLACEMENT PARTS

Even quality-built equipment such as this electric generator may need occasional replacement parts to maintain it in good condition over the years. To order replacement parts, please give the following information:

- Model No. Rev. Level and Serial No. found on the Data Decal.
- Parts number or numbers as shown in the Parts List section.
- A brief description of the trouble with the generator.

FIRMAN 3 Years Limited Warranty

Warranty Qualifications

FIRMAN GENERATOR will register the warranty upon receipt of your Warranty Registration Card and a copy of your sales receipt from one of FIRMAN's retail locations as proof of purchase. Please submit your warranty registration and your proof of purchase within ten(10) days of the date of purchase.

Repair/Replacement Warranty

FIRMAN warrants to the original purchaser that the mechanical and electrical components will be free of defects in material and workmanship for a period of one(1) year(parts and labor) and 3 years (parts and technical support) from the original date of purchase 90 days [parts and labor] and 180 days [parts] for commercial & industrial use. Transportation charges on product submitted for repair or replacement under this warranty are the sole responsibility of the purchaser. This warranty only applies to the original purchaser and is not transferable.

Do Not Return the Unit to the Place of Purchase

Contact the FIRMAN Service Center and FIRMAN will troubleshoot any issue via phone or e-mail. If the problem is not corrected by this method, FIRMAN will, at its option, authorize evaluation, repair or replacement of the defective part or component at a FIRMAN Service Center. FIRMAN will provide you with a case number for warranty service. Please keep it for future reference. Repairs or replacements without prior authorization, or at an unauthorized repair facility, will not be covered by this warranty.

Warranty Exclusions

This warranty does not cover the following repairs and equipment.

Normal Wear

Your product needs periodic parts and service to perform well. This warranty does not cover repair when normal use has exhausted the life of a part or the equipment as a whole.

Installation, Use and Maintenance

This warranty will not apply to parts and/or labor if your product is deemed to have been misused, neglected, involved in an accident, abused, loaded beyond the generator's limits, modified, installed improperly or connected incorrectly to any electrical component. Normal maintenance is not covered by this warranty.

Other Exclusions

This warranty excludes:

- cosmetic defects such as paint, decals, etc.
- wear items
- accessory parts
- failures due to acts of God and other force majeure events beyond the manufacturer's control
- problems caused by parts that are not original FIRMAN parts
- units used for prime power in place of existing utility power where utility is present or in place of utility power where utility power service does not normally exist.

Limits of Implied Warranty and Consequential Damage

FIRMAN disclaims any obligation to cover any loss of time, use of this product, freight, or any incidental or consequential claim by anyone from using this product. THIS WARRANTY IS IN LIEU OF ALL OTHER WARRANTIES, EXPRESS OR IMPLIED, INCLUDING WARRANTIES OF MERCHANTABILITY OR FITNESS FOR A PARTICULAR PURPOSE.

A unit provided as an exchange will be subject to the warranty of the original unit. The length of the warranty governing the exchanged unit will remain calculated by reference to the purchase date of the original unit.

This warranty gives you certain legal rights which may change from state to state. Your state may also have other rights you may be entitled to that are not listed within this warranty.

Contact Information

You may contact FIRMAN at:

Address

Firman Power Equipment Inc.
Attn: Customer Service
8716 W. Ludlow Dr. Suite #6
Peoria, AZ 85381
www.firmanpowerequipment.com

We are FIRMAN POWER - And we are here for you.

FIRMAN POWER EQUIPMENT INC. Emission Control System Warranty

CALIFORNIA AND FEDERAL EXHAUST AND EVAPORATIVE EMISSIONS CONTROL WARRANTY STATEMENT

YOUR WARRANTY RIGHTS AND OBLIGATIONS

The California Air Resources Board, US Environmental Protection Agency ("US EPA") and FIRMAN POWER EQUIPMENT INC.(FIRMAN) are pleased to explain the emissions control systems warranty on your 2021-2022 or later Small Off-Road Engine ("SORE") and engine powered equipment. In California, new equipment that use small off-road engines must be designed, built and equipped to meet the State's stringent anti-smog standards. FIRMAN must warrant the emissions control systems on your SORE and engine powered equipment for the periods of time listed below provided there has been no abuse, neglect or improper maintenance of your small off-road engine or equipment leading to the failure of the emissions control system. Your emissions control system may include parts such as the carburetor or fuel-injection system, the ignition system, catalytic converter, fuel tanks, fuel lines (for liquid fuel and fuel vapors), fuel caps, valves, canisters, filters, clamps and other associated components. Also included may be hoses, belts, connectors, and other emission-related assemblies.

Where a warrantable condition exists, FIRMAN will repair your SORE and engine powered equipment at no cost to you including diagnosis, parts and labor.

MANUFACTURER'S WARRANTY COVERAGE:

The exhaust and evaporative emissions control system on your small off-road engine and engine powered equipment is warranted for two years. If any emissions-related part on your small off-road engine and engine powered equipment is defective, the part will be repaired or replaced by FIRMAN.

OWNER'S WARRANTY RESPONSIBILITIES:

As the SORE and engine powered equipment owner, you are responsible for the performance of the required maintenance listed in your owner's manual. FIRMAN recommends that you retain all receipts covering maintenance on your SORE and engine powered equipment, but FIRMAN cannot deny warranty coverage solely for the lack of receipts or for your failure to ensure the performance of all scheduled maintenance.

As the SORE and engine powered equipment owner, you should however be aware that FIRMAN may deny you warranty coverage if your small off-road engine or engine powered equipment or a part has failed due to abuse, neglect, or improper maintenance or unapproved modifications.

You are responsible for presenting your small off-road engine and engine powered equipment to a FIRMAN distribution center or service center as soon as the problem exists. The warranty repairs shall be completed in a reasonable amount of time, not to exceed 30 days.

If you have any questions regarding your warranty rights and responsibilities, you should contact FIRMAN at 1-844-347-6261.

FIRMAN Emission Control Defects Warranty Provisions

The warranty period begins on the date the engine/equipment is delivered to an ultimate purchaser. FIRMAN warrants to the ultimate purchaser and each subsequent purchaser that the engine is:

Designed, built, and equipped so as to conform with all applicable regulations adopted by the Air Resources Board and US EPA; and Free from defects in materials and workmanship that cause the failure of a warranted part to be identical in all material respects to the part as described in the engine manufacturers application for certification.

The warranty on emissions-related parts is as follows:

- (1) Any warranted part that is not scheduled for replacement as required maintenance in the owner's manual supplied, is warranted for the warranty period stated above. If any such part fails during the period of warranty coverage, the part will be repaired or replaced by FIRMAN at no charge to the owner. Any such part repaired or replaced under the warranty will be warranted for the remaining warranty period.
- (2) Any warranted part that is scheduled only for regular inspection in the owner's manual supplied, is warranted for the warranty period stated above. Any such part repaired or replaced under warranty will be warranted for the remaining warranty period.
- (3) Any warranted part that is scheduled for replacement as required maintenance in the owner's manual supplied, is warranted for the period of time prior to the first scheduled replacement point for that part. If the part fails prior to the first scheduled replacement, the part will be repaired or replaced by FIRMAN at no charge to the owner. Any such part repaired or replaced under warranty will be warranted for the remainder of the period prior to the first scheduled replacement point for the part.
- (4) Repair or replacement of any warranted part under the warranty must be performed at no charge to the owner at a warranty station.
- (5) Notwithstanding the provisions of Subsection (4) above, warranty services or repairs must be provided by FIRMAN that are franchised to service the subject engines.
- (6) The owner must not be charged for diagnostic labor that leads to the determination that a warranted part is in fact defective, provided that such diagnostic work is performed at a warranty station.
- (7) FIRMAN is liable for damages to other engine components proximately caused by a failure under warranty of any warranted part.

- (8) Throughout the emissions warranty period defined in Subsection (b)(2), FIRMAN will maintain a supply of warranted parts sufficient to meet the expected demand for such parts.
- (9) Any replacement part may be used in the performance of any warranty maintenance or repairs and must be provided without charge to the owner. Such use will not reduce the warranty obligations of the manufacturer.
- (10) Add-on or modified parts that are not exempted by the Air Resources Board may not be used. The use of any non-exempted add-on or modified parts by the ultimate purchaser will be grounds for disallowing a warranty claim.
- The manufacturer will not be liable to warrant failures of warranted parts caused by the use of a non-exempted add-on or modified part.

PARTS COVERED BY WARRANTY

Listed below are the parts (if equipped) covered by the Federal and California Emission Control System Warranty.

<p>1. Ignition system including:</p> <ul style="list-style-type: none"> - Spark plug - Ignition coil 	<p>4. Air induction system including:</p> <ul style="list-style-type: none"> - Intake pipe/manifold - Air cleaner
<p>2. Fuel metering system:</p> <ul style="list-style-type: none"> - Fuel tank - Fuel cap - Fuel lines (for liquid fuel and fuel vapors) and related fittings/clamps - Fuel regulator, carburetor and internal parts. 	<p>5. Crankcase breather assembly including:</p> <ul style="list-style-type: none"> - Breather connection tube
<p>3. Catalytic muffler assembly including:</p> <ul style="list-style-type: none"> - Exhaust manifold - Catalytic converter - Muffler gasket -pulse valve 	<p>6. Fuel tank evaporative emission control system including:</p> <ul style="list-style-type: none"> - Purge valves - Carbon canister - Vapor hoses and fitting/clamps

Limitations

This Emission Control System Warranty shall not cover any of the following:

- (a) Consequential damages such as loss of time, inconvenience, loss of use of the engine or equipment, etc.
- (b) Diagnosis and inspection fees that do not result in eligible warranty service being performed.

FIRMAN POWER EQUIPMENT INC.
www.firmanpowerequipment.com

FOLLOW US ON SOCIAL MEDIA

USE

#EVERYGENERATORTELLSASTORY™

FOR YOUR CHANCE TO WIN FIRMAN SWAG



**FIRMAN POWER EQUIPMENT
8716 W LUDLOW DR. SUITE #6
PEORIA, AZ 85381
1-844-347-6261
WWW.FIRMANPOWEREQUIPMENT.COM**

All rights reserved. Any reprinting or unauthorized use without the written permission is expressly prohibited.
P/N:317745454 Rev:00