

# UNIT SPECIFICATIONS

MODEL # 1605 REV LEVEL:00 P/N: 336457006  
 Adapter L5-30P /TT-30R RV

Project Manager: Jaleel  
 Document Rev: 00

- Notes :1、 Based on model main changes sign with “▼”  
 2、 document modification sign with green color 11111

## Product description

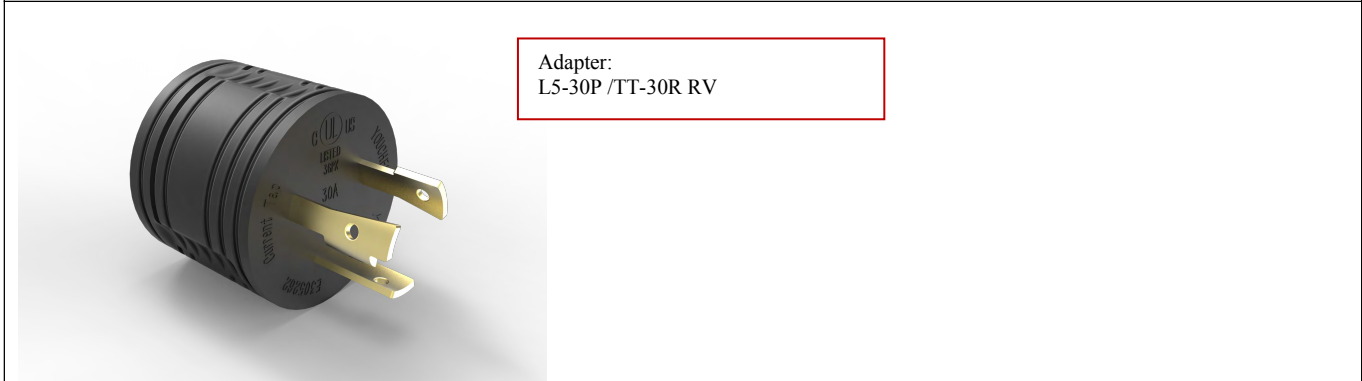

## 1.Key Features

<input checked="" type="checkbox"/> New Model	<input type="checkbox"/> Based on Model:
	Main changes/features

## 2.Require Certifications

<input type="checkbox"/> EPA EXH Phase 3	<input type="checkbox"/> EVAP CARB	<input type="checkbox"/> USDA FS Approval	<input checked="" type="checkbox"/> RoHS
<input type="checkbox"/> CARB EXH	<input checked="" type="checkbox"/> UL	<input type="checkbox"/> FCC ( Remote Control )	<input type="checkbox"/> OSHA
<input type="checkbox"/> EVAP EPA	<input type="checkbox"/> CSA	<input type="checkbox"/> FCC ( Complete Generator )	

## 3.Electrical Specifications

Nominal Rating	Amps	Volts	Watts				
AC	30	125	3750				

## 4.General Information

Brand : Firman	Unit Weight (lbs) : 0.22	Shipping Weight (lbs):0.25
Supplier: SuoBen	UPC: 840876100608	Carton Dimension (LxWxH) (inch): 18.9×16.9×5.1
Warranty (day) :120	Max Units Per container:13104/40HQ	

## 5.Component Configuration and Certification

Component	Configuration	Certification	Certification number	Note
Adapter	L5-30P /TT-30R RV	UL	E496994	

## 6.Packaging

Pallet	Yes
Carton Graphic	Litho (Black)
Language	English/Spanish/French
Fixed board	Yes ( 4 colors )
Other	

**7. Other Features**

Other: <input type="checkbox"/>	Other: shippable by UPS	Other: <input type="checkbox"/>	Other: <input type="checkbox"/>
Other: <input type="checkbox"/>	Other: <input type="checkbox"/>	Other: <input type="checkbox"/>	Other: <input type="checkbox"/>

**General Notes:**

1. **Dimensions:** Unit dimensions are the outside dimensions of the carton.
2. **Weight:** Unit weight is for a complete packaged unit.
3. **Components requirements:**
  - a. All electrical components including receptacles, plugs, circuit breakers and wires must be UL or CSA (or cUL) certified.
  - b. All wires must be insulated, stranded copper wire rated for 105° C and 300V.
  - c. All terminals must be sized correctly for the anticipated current and voltage.
4. **Testing Requirements:**
  - a. Each power cord must demonstrate the ability to produce required voltage, frequency, and power which is listed on Testing Specs.
  - b. Dielectric Withstand Test (Hipot): 2500 V for 5 second (set leak current at 5mA).
5. **Enclosures:**
  - a. Whether constructed of metal or plastic, enclosures must be sufficiently strong to perform their required duty without damage.
  - b. All polymeric enclosures must be sufficiently strong to pass the CSA C22.2 No. 100-04 Impact Test.
  - c. All polymeric enclosures exposed to sunlight must contain appropriate UV stabilizers.
6. **Decals/labels:**
  - a. Decals must be impervious to water, gasoline, and sunlight and suitable for long-term outdoor exposure.
  - b. Decals must be free of wrinkles and bubbles after installation.
  - c. Decals must be positioned correctly. Crooked decals are not acceptable.
7. **Packaging:**
  - a. EAN/UPC decal and serial number decal: The serial numbers of the units on the skid must be visible and not covered by other units.
  - b. Dirt: The products must be cleaned before shipping. Dirt on products is not acceptable.
  - c. Big plastic bag: The big plastic bag for packaging the unit must be printed with "Suffocation Warning" in English, French, and Spanish.
  - d. Pallets and internal wooden parts will require fumigation.
  - e. Units must be packaged and palletized appropriately to prevent damage during transportation and handling. The units on the pallet must be wrapped together.
8. **Banned materials:** Asbestos, Cadmium (Cd), Mercury (Hg), and Lead (Pb) are not allowed in any components.
9. **Protection against corrosion:** All material including hinges, guards, enclosures, and frames formed of iron or steel shall be protected against corrosion by painting, galvanizing, plating, or by other equivalent means.
10. **Sharp edges:** An edge, a projection, and a corner of an enclosure, frame, guard, or the like, shall be smooth and rounded, and not sufficiently sharp to constitute a risk of injury to persons in normal maintenance and use of a product.
11. **Main Components suppliers:** The power cord manufacturer is not allowed to change the main components supplier such as receptacle, wire, circuit breaker, and plug before Firman approval. New parts need to be shipped to Firman for evaluation, testing and approval.

# UNIT SPECIFICATIONS

MODEL # 1605 REV LEVEL:00 P/N: 336457006  
 Adapter L5-30P /TT-30R RV

## 8.Overall Dimensions

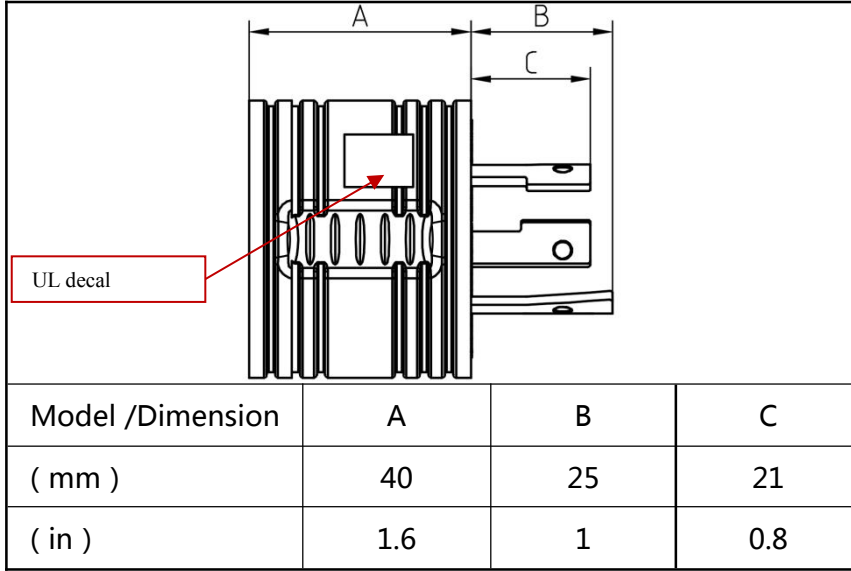

## Unit information

### Color system

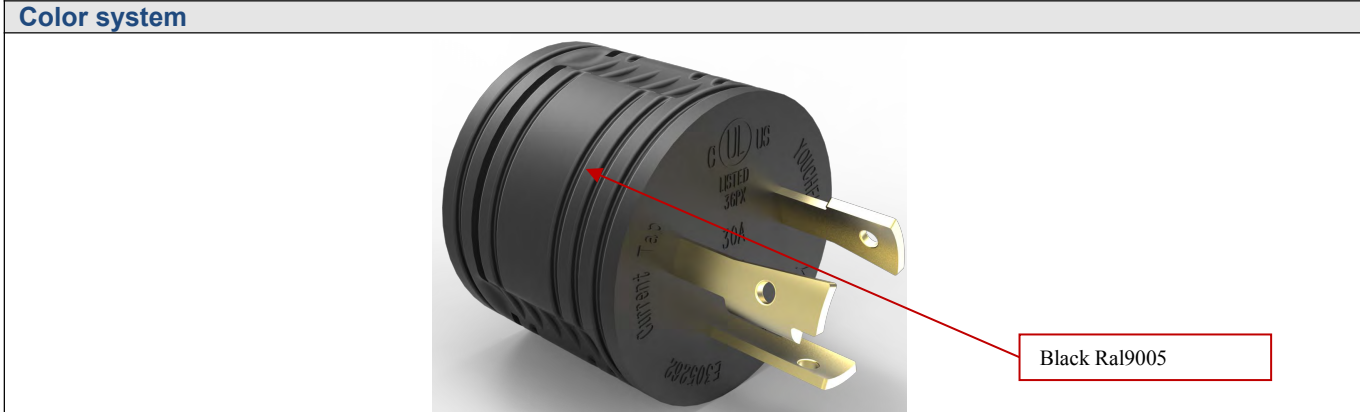

### Configuration

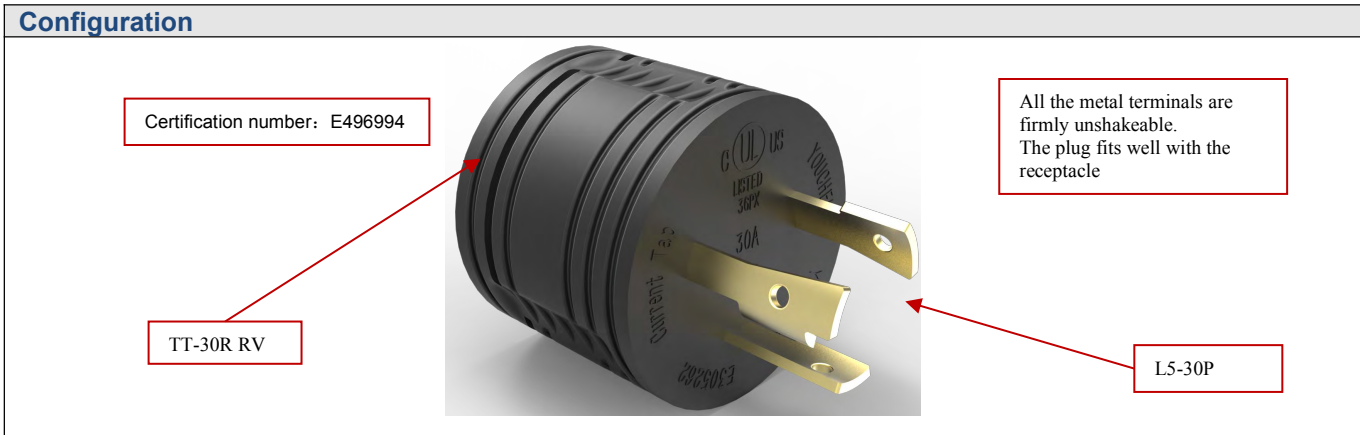

# UNIT SPECIFICATIONS

MODEL # 1605 REV LEVEL:00 P/N: 336457006  
Adapter L5-30P /TT-30R RV

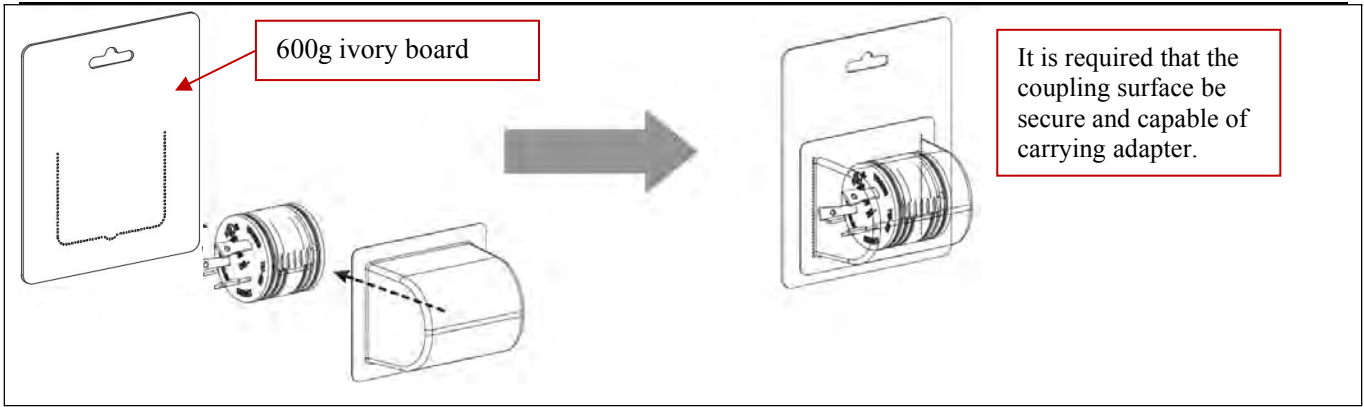

## 9.Package

### Packing instruction

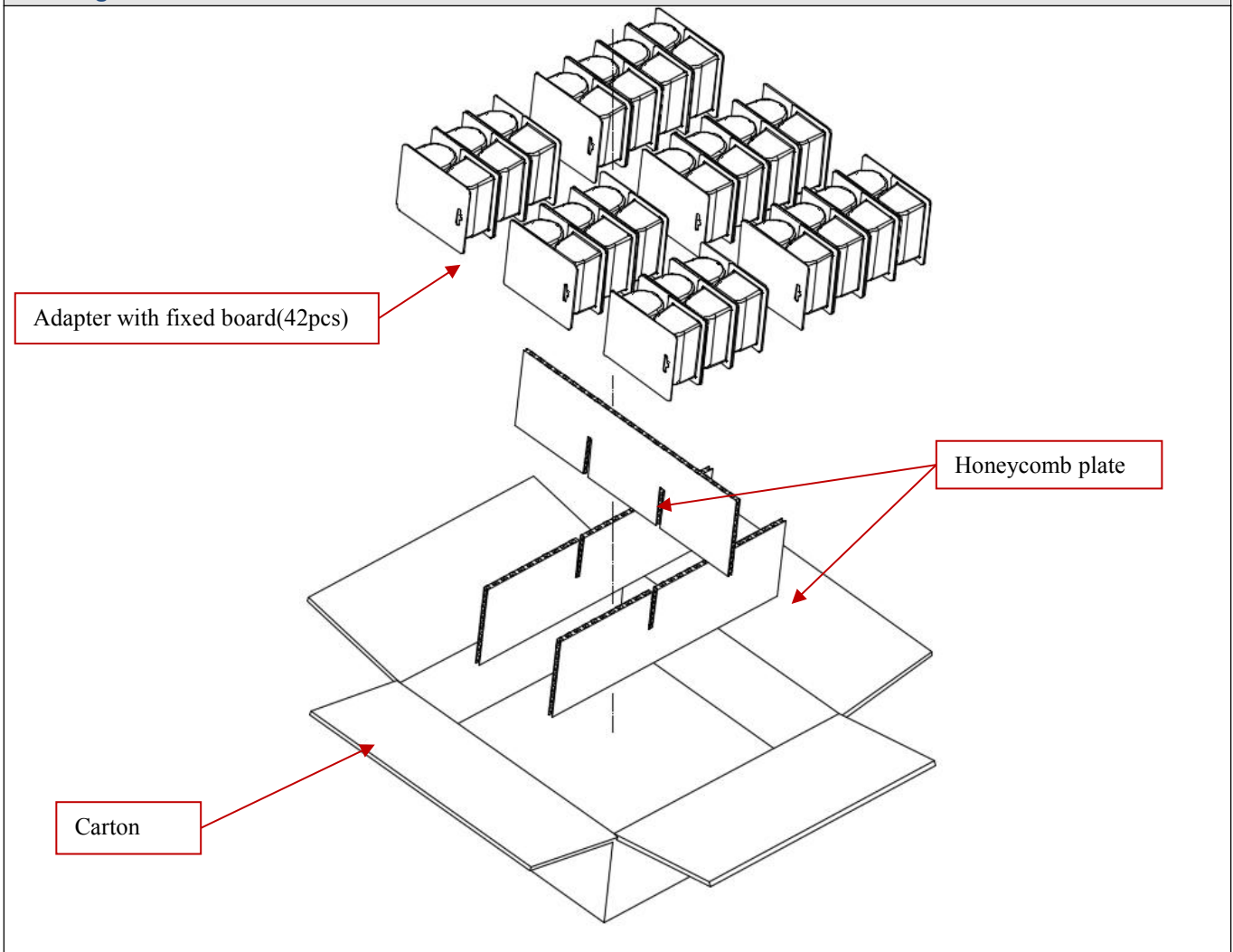

# UNIT SPECIFICATIONS

MODEL # 1605 REV LEVEL:00 P/N: 336457006  
 Adapter L5-30P /TT-30R RV

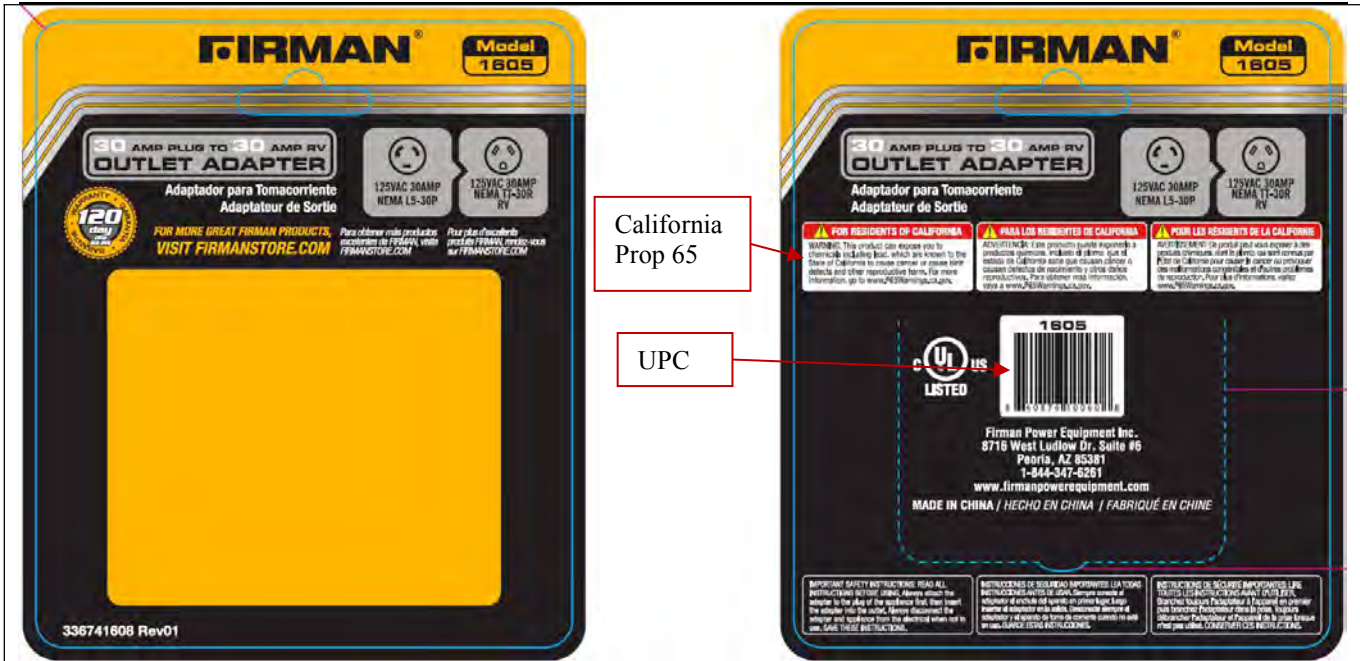

California Prop 65

UPC

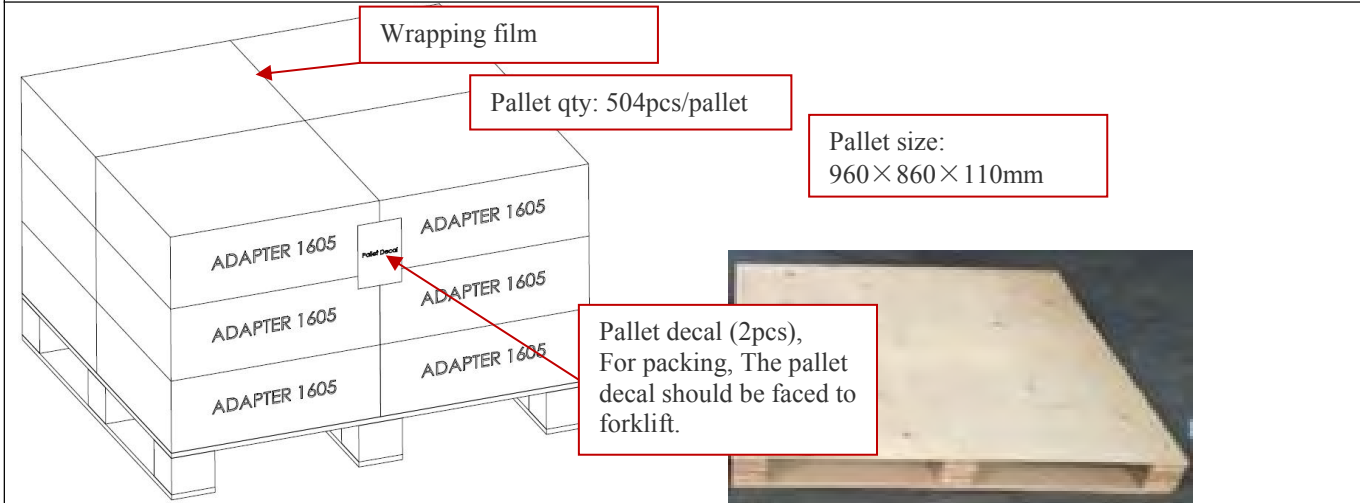

Wrapping film

Pallet qty: 504pcs/pallet

Pallet size:  
960 × 860 × 110mm

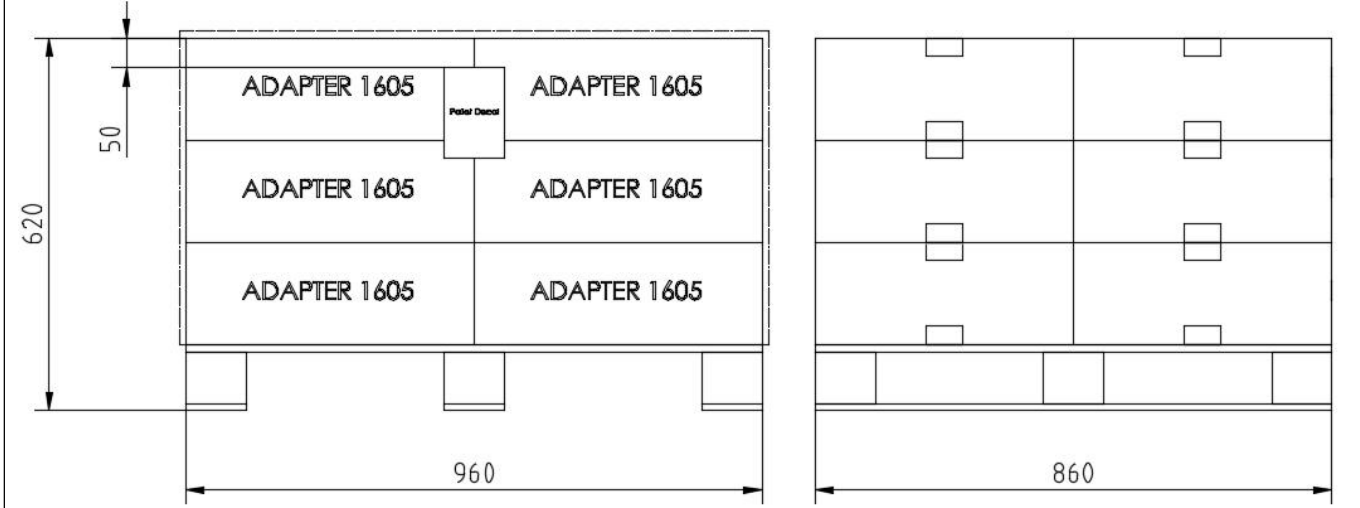

Pallet decal (2pcs),  
For packing. The pallet  
decal should be faced to  
forklift.



# UNIT SPECIFICATIONS

MODEL # 1605 REV LEVEL:00 P/N: 336457006  
 Adapter L5-30P /TT-30R RV

## 17.Package Decals

Pallet decal P/N : 336737036 Rev : 00	Outer packing carton P/N : 336747058 Rev : 00
	

## 18.Shipping information

Carton dimension (External) 纸箱外部尺寸				Unit weight 运输整机重量	
	L	W	H	kg	lbs
(mm)	480	430	170	6.7	14.7
(in)	18.9	16.9	5.1		

Pallet dimension 托盘尺寸				Pallet weight 托盘重量	
	L	W	H	kg	lbs
(mm)	960	860	110	11.6	25.5
(in)	37.8	33.9	4.3		

Pallet layout 托盘布置 (台数)			Units Per pallet 台数/托	Pallet weight (with unit) 托盘总重量	
L	W	H		kg	lbs
2	2	3	504	92	202.4

Full pallet dimension 整托尺寸 (mm)			Full pallet dimension 整托尺寸 (in)		
L	W	H	L	W	H
960	860	620	37.8	33.9	24.4



# UNIT SPECIFICATIONS

MODEL # 1605 REV LEVEL:00 P/N: 336457006  
 Adapter L5-30P /TT-30R RV

Container quantity 装柜数量		Total weight 总重	
Total pallets 总托盘数	Total units 总机组数量	kg	lbs
26	13104	2392	5262

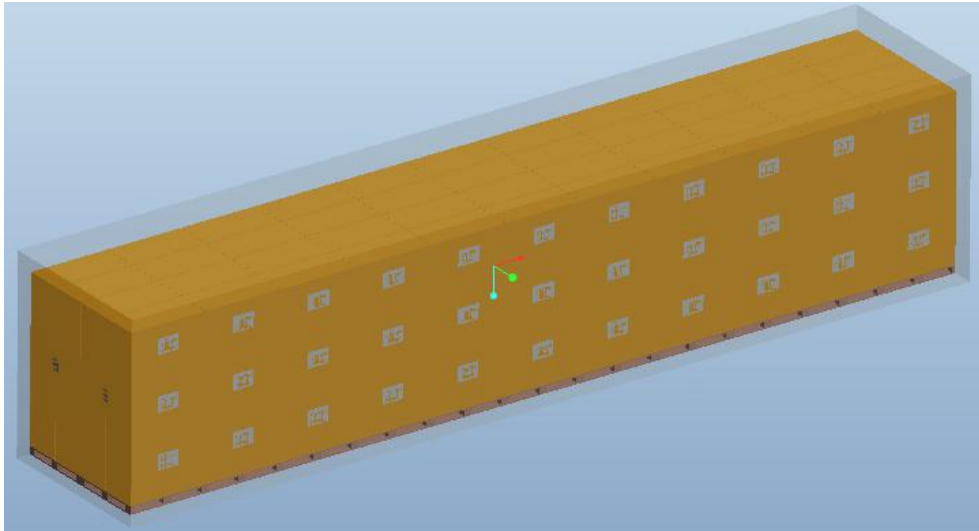

Revisions				
REV	Change page	Description	Date	By
00			2018-11-01	SZH

编制/TRACED	校对/PROOFREAD	认证审核 /Certification audit	审核/CHECKED	批准/APPROVED
Shi Zhihao	Ma Jiazhong	Wu Yue	Jaleel	Michael