

REL NO	REV	NO	REVISION	DRN	CKD	APVD	DATE
ECO-166256	E	1	ADD NOTE 3	PT	MT	M_TULADHAR	28NOV16
		2	ZONE (A4), ADD BATTERY DIAGRAM TO STARTER	PT	MT	M_TULADHAR	28NOV16
		3	ZONE (B6) ADD 'ETHERNET J3' TO DISPLAY	PT	MT	M_TULADHAR	28NOV16
		4	SEE SHEET 2	PT	MT	M_TULADHAR	28NOV16

- NOTES:
- ALL DEVICES ARE SHOWN DE-ENERGIZED WITH TRANSFER SWITCH CLOSED TO UTILITY.
 - SINGLE PHASE TRUE TWO POSITION MECHANISM. MAXIMUM VOLTAGE UPTO 240 VAC.
 - SEE SHEET 2 FOR EMERGENCY STOP KIT CONNECTION (ZONE A1).

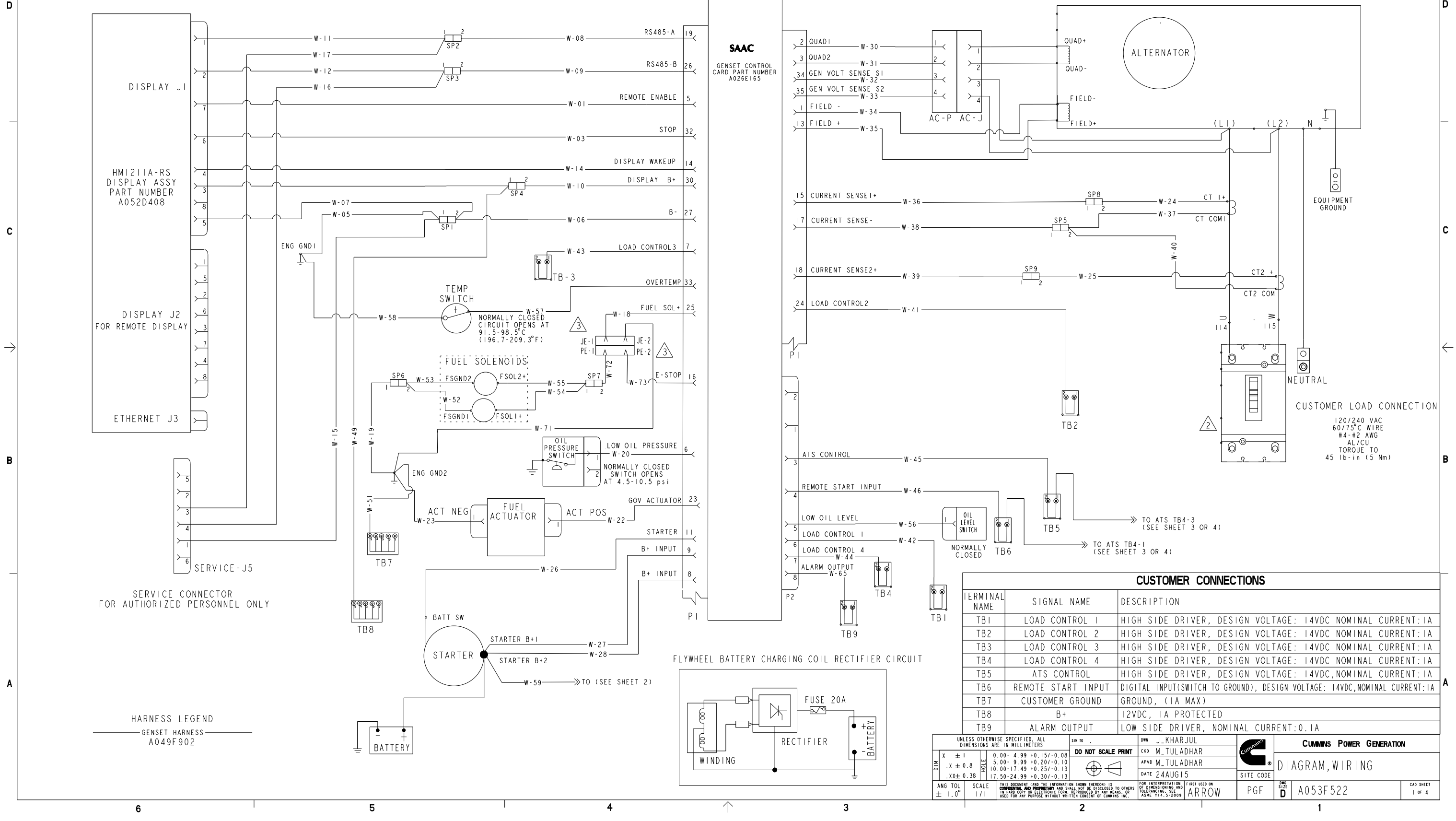

CUSTOMER CONNECTIONS

TERMINAL NAME	SIGNAL NAME	DESCRIPTION
TB1	LOAD CONTROL 1	HIGH SIDE DRIVER, DESIGN VOLTAGE: 14VDC NOMINAL CURRENT: 1A
TB2	LOAD CONTROL 2	HIGH SIDE DRIVER, DESIGN VOLTAGE: 14VDC NOMINAL CURRENT: 1A
TB3	LOAD CONTROL 3	HIGH SIDE DRIVER, DESIGN VOLTAGE: 14VDC NOMINAL CURRENT: 1A
TB4	LOAD CONTROL 4	HIGH SIDE DRIVER, DESIGN VOLTAGE: 14VDC NOMINAL CURRENT: 1A
TB5	ATS CONTROL	HIGH SIDE DRIVER, DESIGN VOLTAGE: 14VDC, NOMINAL CURRENT: 1A
TB6	REMOTE START INPUT	DIGITAL INPUT(SWITCH TO GROUND), DESIGN VOLTAGE: 14VDC, NOMINAL CURRENT: 1A
TB7	CUSTOMER GROUND	GROUND, (1A MAX)
TB8	B+	12VDC, 1A PROTECTED
TB9	ALARM OUTPUT	LOW SIDE DRIVER, NOMINAL CURRENT: 0.1A

UNLESS OTHERWISE SPECIFIED, ALL DIMENSIONS ARE IN MILLIMETERS		SW TO	DO NOT SCALE PRINT	DWN J_KHARJUL	CUMMINS POWER GENERATION
DIM	TOLERANCE	SCALE	DATE 24AUG15	CKD M_TULADHAR	
X ± 1	0.00 - 4.99 +0.15/-0.08	1/1	FOR INTERPRETATION OF DIMENSIONS AND TOLERANCING, SEE ASME Y14.5-2009	APVD M_TULADHAR	DIAGRAM, WIRING
.X ± 0.8	5.00 - 9.99 +0.20/-0.10			DATE 24AUG15	
.XX ± 0.38	10.00 - 17.49 +0.25/-0.13			PGF	A053F522
ANG TOL ± 1.0°	17.50 - 24.99 +0.30/-0.13			ARROW	

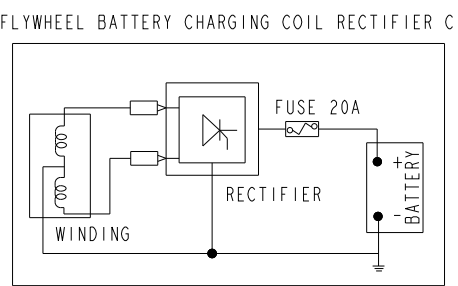

REL NO	REV	NO	REVISION	DWN	CKD	APVD	DATE
ECO-166256	E	4	ZONE (A1) ADD EMERGENCY STOP CONNECTION	PT	MT	M_TULADHAR	28NOV16

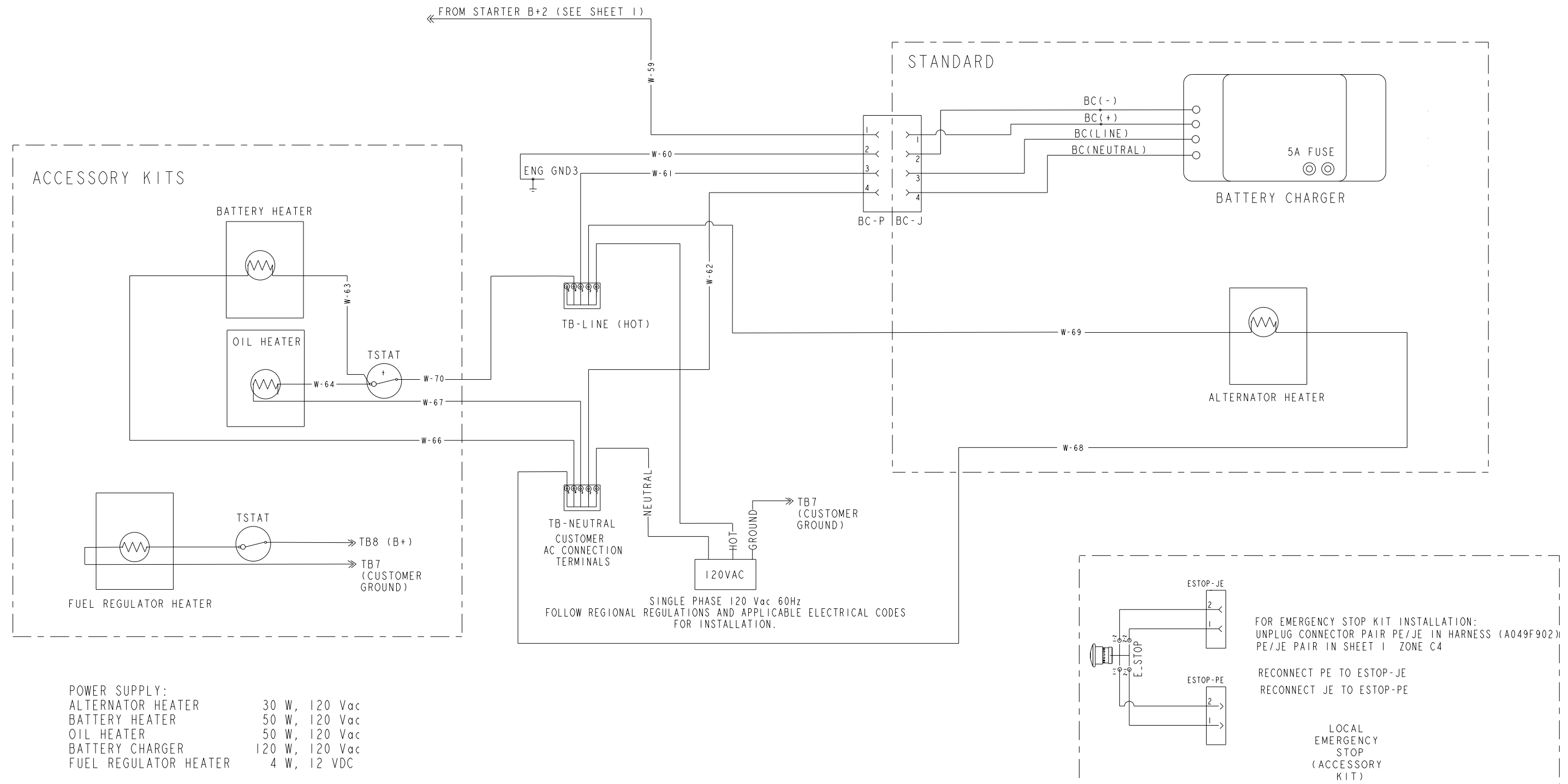

POWER SUPPLY:

ALTERNATOR HEATER	30 W, 120 Vac
BATTERY HEATER	50 W, 120 Vac
OIL HEATER	50 W, 120 Vac
BATTERY CHARGER	120 W, 120 Vac
FUEL REGULATOR HEATER	4 W, 12 VDC

OPERATING TEMPERATURE THERMOSTAT (TSTAT):
OFF ABOVE 30°F (-1°C)
ON BELOW 10°F (-12°C)

UNLESS OTHERWISE SPECIFIED, ALL DIMENSIONS ARE IN MILLIMETERS		SW TO	DWN	CKD	APVD	DATE	CUMMINS POWER GENERATION	
DIM	X ± 1	0.00 - 4.99 +0.15/-0.08	DO NOT SCALE PRINT	J_KHARJUL	M_TULADHAR	24AUG15	DIAGRAM, WIRING	
	.X ± 0.8	5.00 - 9.99 +0.20/-0.10						
	.XX ± 0.38	10.00 - 17.49 +0.25/-0.13						
		17.50 - 24.99 +0.30/-0.13						
ANG TOL	± 1.0°	THIS DOCUMENT (AND THE INFORMATION SHOWN THEREON) IS CONFIDENTIAL AND PROPRIETARY AND SHALL NOT BE DISCLOSED TO OTHERS IN HARD COPY OR ELECTRONIC FORM, REPRODUCED BY ANY MEANS, OR USED FOR ANY PURPOSE WITHOUT WRITTEN CONSENT OF CUMMINS INC.		FIRST USED ON	ARROW	PGF	A053F522	CAD SHEET 2 of 4

ATS WIRING WITH RA100, RA200, RA100SE, RA200SE, RA400, RA400SE

REL NO	REV	NO	REVISION	DRN	CKD	APVD	DATE
ECO-166256	E	--	---	PT	MT	M_TULADHAR	28NOV16

NOTES:

- 1 SERVICE ENTRANCE MODELS ONLY.
- 2 LOCATED ON THE SIDE OF THE ATS MECHANISM.
- 3 INSTALL JUMPER A034N106 SUPPLIED IN SHIPPING PARTS BAG WITH GENSET.

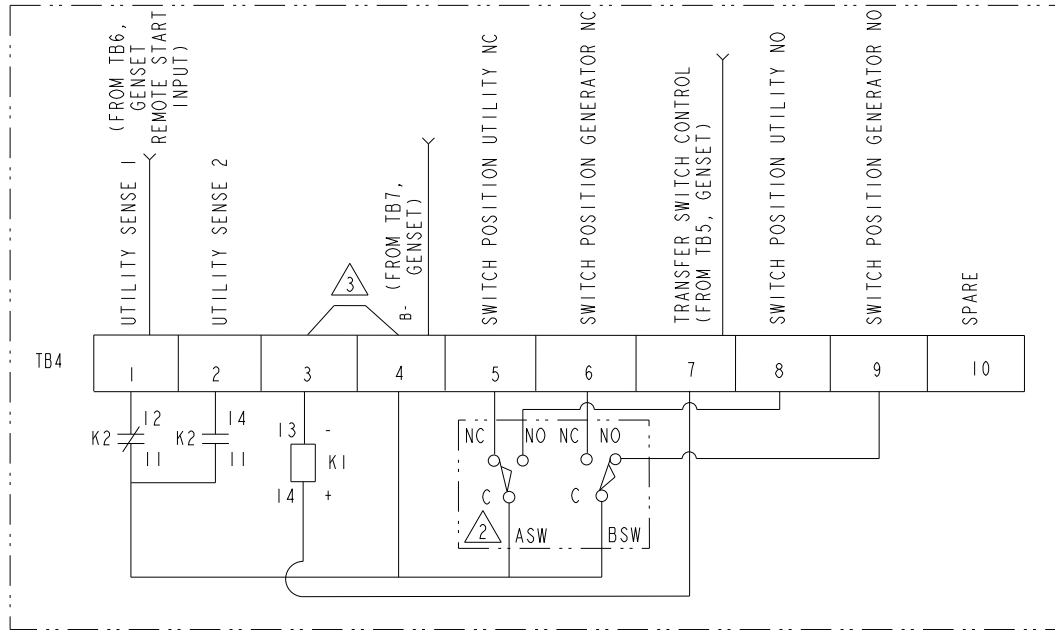

- TB4 TERMINAL BLOCK
- K1 RELAY
- ASW UTILITY POSITION AUXILIARY SWITCH
- BSW GENERATOR POSITION AUXILIARY SWITCH
- ATS AUTOMATIC TRANSFER SWITCH
- K2 UTILITY SENSE RELAY
- S1 OPEN WHEN ATS IS CONNECTED TO UTILITY
- S2 OPEN WHEN ATS IS CONNECTED TO GENERATOR
- CR1 BRIDGE RECTIFIER
- C ATS OPERATOR COIL
- CBI UTILITY CIRCUIT BREAKER

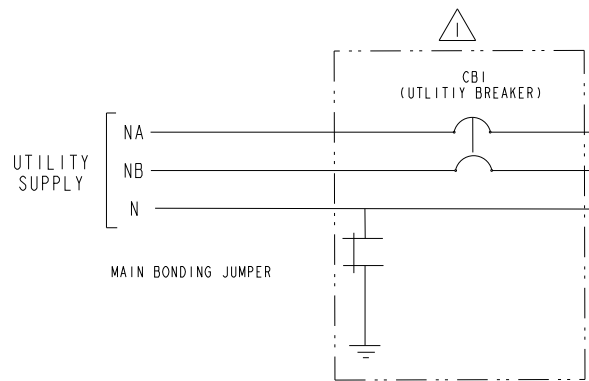
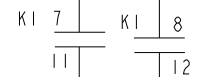
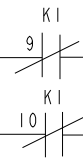
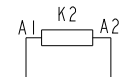
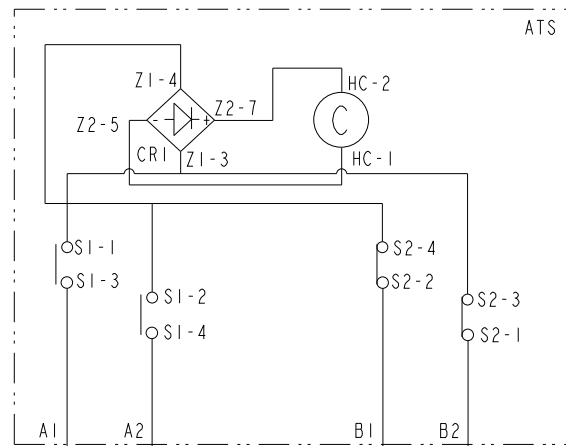

LOAD CONNECTIONS
LA LB N

UNLESS OTHERWISE SPECIFIED, ALL DIMENSIONS ARE IN MILLIMETERS		SHW TO	DWN J_KHARJUL		CUMMINS POWER GENERATION	
DO NOT SCALE PRINT			CKD M_TULADHAR		DIAGRAM, WIRING	
DIM	TOLERANCE		APVD M_TULADHAR	SITE CODE		
X ± 1	0.00- 4.99 +0.15/-0.08		DATE 24AUG15			
.X ± 0.8	5.00- 9.99 +0.20/-0.10					
.XX ± 0.38	10.00-17.49 +0.25/-0.13					
	17.50-24.99 +0.30/-0.13					
ANG TOL	SCALE	THIS DOCUMENT (AND THE INFORMATION SHOWN THEREON) IS CONFIDENTIAL AND PROPRIETARY AND SHALL NOT BE DISCLOSED TO OTHERS IN HARD COPY OR ELECTRONIC FORM, REPRODUCED BY ANY MEANS, OR USED FOR ANY PURPOSE WITHOUT WRITTEN CONSENT OF CUMMINS INC.	FOR INTERPRETATION OF DIMENSIONING AND TOLERANCING, SEE ASME Y14.5-2009	FIRST USED ON	ARROW	PGF
± 1.0°	1/1			DATE	D	A053F522
						CAD SHEET 3 of 4

REL NO	REV	NO	REVISION	DRN	CKD	APVD	DATE
ECO-166256	E	--	---	PT	MT	M_TULADHAR	28NOV16

ATS WIRING WITH RA112L1

NOTE:

▲ INSTALL JUMPER A034N106 SUPPLIED IN SHIPPING PARTS BAG WITH GENSET.

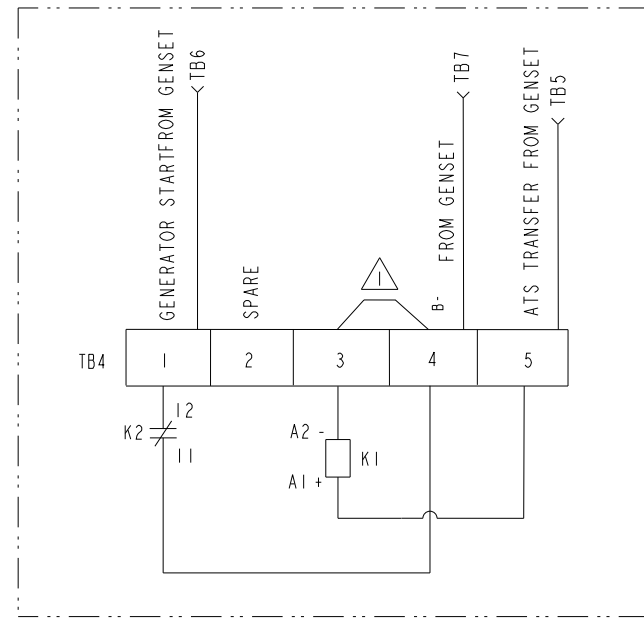

- TB4 TERMINAL BLOCK
- K1 RELAY
- ATS AUTOMATIC TRANSFER SWITCH
- K2 UTILITY SENSE RELAY
- S1 OPEN WHEN ATS IS CONNECTED TO UTILITY
- S2 OPEN WHEN ATS IS CONNECTED TO GENERATOR
- CB1 UTILITY CIRCUIT BREAKER

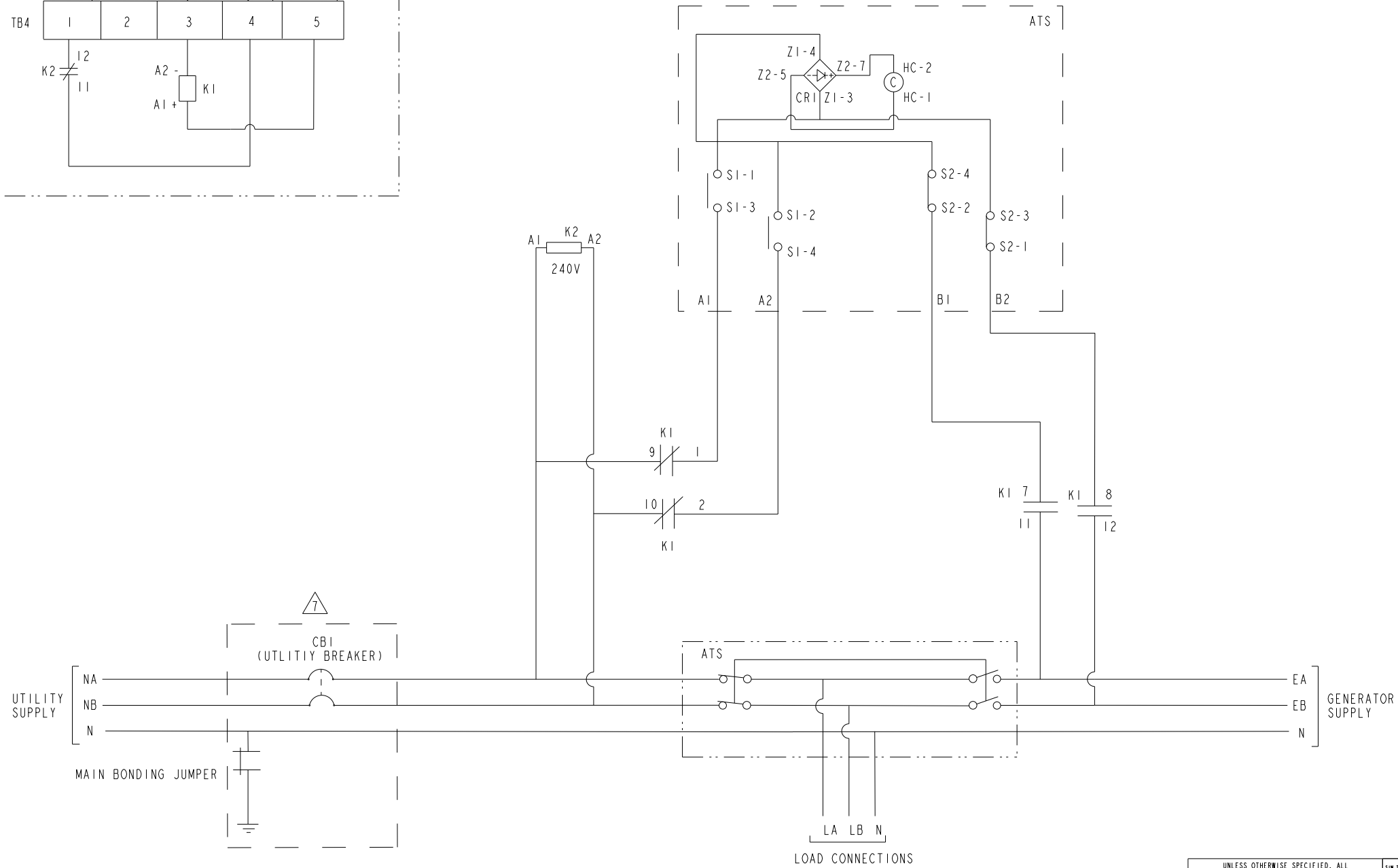

UNLESS OTHERWISE SPECIFIED, ALL DIMENSIONS ARE IN MILLIMETERS		SHW TO	DWN J_KHARJUL		CUMMINS POWER GENERATION
DO NOT SCALE PRINT		CKD M_TULADHAR	APVD M_TULADHAR		DATE 24AUG15
DIM X ± 1 .X ± 0.8 .XX ± 0.38	TOLERANCE 0.00- 4.99 +0.15/-0.08 5.00- 9.99 +0.20/-0.10 10.00-17.49 +0.25/-0.13 17.50-24.99 +0.30/-0.13		FIRST USED ON FOR INTERPRETATION OF DIMENSIONING AND TOLERANCING, SEE ASME Y14.5-2009	PGF	SITE CODE A053F522
ANG TOL ± 1.0°	SCALE 1/1	ARROW	PGF	SHEET D 4 OF 4	CAD SHEET 4 OF 4

Part A053F522 E

Description	Legacy Name	External Regulations	Application Status	Release Phase Code	Security Classification	Alternates
DIAGRAM,WIRING	A053F522	No External Regulations Apply	Production Only	Production	Confidential	

Part Specifications :A053F522 E

Name	Description	Legacy Name
A030B356	SPECIFICATION,MATERIAL	CES10903
A053F523	DRAWING,ENGINEERING	A053F523